

H4next *Handy Recorder*

OPERATION MANUAL

ZOOM

© ZOOM Corporation

Special features of H4n

Thank you very much for purchasing our ZOOM H4n Handy Recorder (hereinafter abbreviated to H4n). The H4n has the following special features.

- **An all-in-one handy recorder.**

You can enjoy recording and creating your own music any time, anywhere with the H4n.

The H4n has a very compact 280 g lightweight design, equipped with high quality stereo condenser microphones arranged in an XY pickup pattern, a built-in speaker, SD card recording, mixer and internal effects.

- **Versatile field recorder with multi-track capability.**

The H4n is capable of recording in several different operation modes: <STEREO mode> which is capable of high quality stereo recording; <4CH mode> which can record 4 discrete channels simultaneously using the on-board microphones and the external inputs; <MTR mode> which allows you to record multiple tracks in multiple passes, overdubbing one or two tracks at a time. In <STAMINA mode> you can record for up to 11 hours using batteries only.

- **Newly designed XY stereo microphones allow variable recording patterns from 90 to 120 degrees.**

The H4n allows the user to adjust the angle of the onboard microphones to address a wider range of recording scenarios. If you want a wider area of sound, you can set the microphones to 120 degrees. Or set them to 90 degrees for a more focused sound source. Either way, the mics retain their XY configuration, so you can record natural stereo sound with no phase cancellation.

- **XLR-1/4-inch combo jacks allow direct connection of any sound source.**

We've loaded the H4n with a versatile array of input options to accommodate a variety of recording sources. Any type of microphone (including condensers), electric instrument (guitar, bass, keyboard) or line level source can be connected to the H4n.

- **It can be used as an Audio Interface/SD card reader for a computer.**

An onboard USB 2.0 Hi-Speed jack allows direct connection to a computer. You can use it as an audio interface with built-in effects (sampling rate 44.1 kHz). You can also use the H4n as an SD card reader for your computer. You can even take the recorded files from your computer and create an audio CD using those files as material in any DAW software.

- **Other built-in functions: Tuner/Metronome/Karaoke.**

The H4n can be used as a standard chromatic tuner. It is also capable of more irregular tuning functions, like for a 7-string guitar or a 5-string bass, along with others. The H4n has a metronome function convenient for practice and multi-track recording.

You can change playback speed between the ranges of 50% to 150%.

There are many other effects functions included, such as center cancel function for stereo files, Karaoke function with variable key control, language learning and voice training function

* Please read this manual carefully to ensure comprehensive knowledge and proper use of the H4n. After reading through it, please keep the manual for future reference

The H4n is ideal for the following scenarios



Vocal recording



Recording acoustic guitar sound



Piano recitals



Live performance recording



The band practices



Transfer analogue sound sources to digital sources



Recording the meetings



Any field sound recording



Drum practice recording

A table of contents

Special features of H4n	001
The H4n is ideal for the following scenarios	002
A table of contents	003
Safety precautions for users	006
Copyright warnings	007

Getting started

1-1 Recording flow using the H4n	009
1-2 Easy recording guide [STEREO MODE]	011
2-1 Name and function of each part	013
2-2 Included Accessories	015
3 Battery/Power setting	017
4-1 Power On and Off, How to use power and hold switch	019
4-2 How to use the [REC] and transport control buttons	021
4-3 How to use the track [1], [2], [3] and [4] buttons	022
4-4 How to use the input [MIC], [1] and [2] buttons	023
4-5 How to use REC LEVEL and VOLUME	024
4-6 How to use [DIAL] and [MENU] buttons	025
5-1 Insert a SD card	027
5-2 Set date and time <DATE/TIME>	028
6-1 Setting up: How to connect external audio devices	029
6-2 Setting up: Built-in microphones	030

6-3 Setting up: Built-in microphones /outside microphone with plug-in power ...	031
6-4 Setting up: INPUT [1], [2] connections and phantom power source	032
6-5 Setting up: USB connection, H4n used as an Audio Interface	033
6-6 Setting up: USB connection, H4n used as a SD card reader	035
6-7 Setting up: Built-in speaker	036
7-1 About H4n modes	037
7-2 Selecting a <MODE>	038
7-3 Details about modes	039
8-1 <MODE> screens: STEREO and STAMINA modes	040
8-2 <MODE> screen: 4CH mode	041
8-3 <MODE> screen: MTR mode	042
8-4 <MODE> screen: MAIN MENU	043
9 Option: Remote control operation	045

Operations

1-01 Setting / Recording: Set input source and recording level	047
1-02 Setting / Recording: Recording in STEREO and STAMINA mode	049
1-03 Setting / Recording: Recording format <REC FORMAT>	051
1-04 Setting / Recording: File name <FILE NAME>	052
1-05 Setting / Recording: Recording on 4CH mode	053
1-06-1 Setting / Recording: Recording in MTR mode	055
1-06-2 Setting / Recording: Recording <OVER WRITE> in MTR mode	057

1-06-3	Setting / Recording: Recording <ALWAYS NEW> in MTR mode	058	3-03-5	Effect <EDIT (EFX) >, editing EFX modules	086
1-07	Setting / Recording: TRACK MENU in MTR mode	059	3-03-6	Effect <EDIT (LEVEL/RENAME) >	087
1-08-1	Setting / Recording: Re-recording, <PUNCH IN/OUT> automatic	061	3-03-7	Effect <EDIT (STORE) >	088
1-08-2	Setting / Recording: Re-recording, <PUNCH IN/OUT> manual	063	3-03-8	Effect <IMPORT>, taking in a patch from another PROJECT	089
2-01-1	Recording function <AUTO REC>	065	3-04-1	A sing-along machine <KARAOKE> preparation	091
2-01-2	Recording function <AUTO REC STOP>	066	3-04-2	A sing-along machine <KARAOKE> recording	093
2-02	Recording function <PRE REC>	067	4-01	Playback : Playback files (stereo, 4ch and stamina modes)	094
2-03	Recording function <LO CUT>	068	4-02	Playback : <PLAY MODE>	095
2-04	Recording function <COMP/LIMIT>	069	4-03	Playback : Setting marks	096
2-05	Recording function <REC LEVEL AUTO>	070	4-04	Playback : <AB REPEAT>	097
2-06	Recording function <MONITOR>	071	4-05	Playback : <SPEED>	099
2-07	Recording function <MONO MIX>	072	4-06	Playback : <MIXER>	100
2-08	Recording function <MS STEREO MATRIX>	073	4-07	Playback : Playback files (MTR mode)	101
3-01-1	Tuner <TUNER (CHROMATIC) >	075	4-08	Playback : Appointing time with a counter	102
3-01-2	Tuner, all other <TUNER>	076	5-01	Edit / Output : <FOLDER SELECT>	103
3-01-3	Tuner <TUNER (CALIB) >	077	5-02	Edit / Output : <FILE SELECT>	104
3-01-4	Tuner <TUNER (INPUT) >	078	5-03	Edit / Output : <FILE INFORMATION>	105
3-02	Metronome <METRONOME>	079	5-04	Edit / Output : <FILE DELETE>	106
3-03-1	All about EFFECT	081	5-05	Edit / Output : <FILE DELETE ALL>	107
3-03-2	Effect <EFFECT>	083	5-06	Edit / Output : <FILE (COPY)>	108
3-03-3	Effect <EDIT>, patch edit	084	5-07	Edit / Output : <FILE RENAME>	109
3-03-4	Effect <EDIT (PRE AMP) >, editing PRE AMP modules	085	5-08	Edit / Output : <FILE MP3 ENCODE>	111

5-09	Edit / Output : <FILE NORMALIZE>	112
5-10	Edit / Output : <FILE STEREO ENCODE>	113
5-11	Edit / Output : <MARK LIST>	115
5-12	Edit / Output : <DIVIDE>	116
5-13	Edit / Output : <MOVE>	117
5-14	Edit / Output : <NEW PROJECT>	118
5-15	Edit / Output : <PROJECT (SELECT) >	119
5-16	Edit / Output : <PROJECT (DELETE) >	120
5-17	Edit / Output : <PROJECT (RENAME) >	121
5-18	Edit / Output : <PROJECT (COPY) >	122
5-19	Edit / Output : <PROJECT (BOUNCE) >	123
5-20	Edit / Output : <PROJECT (PROTECT) >	125
6-01	Utility : <DISPLAY BACK LIGHT>	126
6-02	Utility : <DISPLAY CONTRAST>	127
6-03	Utility : <BATTERY TYPE>	128
6-04	Utility : <VERSION>	129
6-05	Utility : <FACTORY RESET>.....	130
6-06	Utility : <REMAIN>	131
6-07	Utility : <FORMAT>	132
6-08	Utility : <VERSION UP>	133
6-09	Utility: How to use H2 and H4 SD cards	134

Reference

Main spec list by mode	137
Available setting menu list by each mode	138
Effect types on MTR mode and the parameter	139
H4n patch list	145
H4n products spec	147
When you think something may be wrong with your machine.....	148
Index	149

Safety precautions for users

SAFETY PRECAUTIONS

In this manual, the warning and caution symbols are used to highlight dangerous accidents and troubles for users to read so that accidents can be prevented. The meanings of these symbols are as follows:



Warning

If the users ignore this symbol and handle the device the wrong way, serious injury or death could result.



Caution

If the users ignore this symbol and handle the device the wrong way, bodily injury and damage to the equipment could result.

Please read through the following safety tips and precautions to ensure hazard-free use of the H4n.

Power requirements



Warning

Since power consumption of this unit is fairly high, we recommend the use of an AC adapter whenever possible. In case you use batteries, use either alkaline or nickel-metal hydride batteries.

[AC adapter operation]

- Make sure to use only an AC adapter, DC5 center plus 1A (ZOOM AD 14). The use of other than the specified type may damage the unit and pose a safety hazard.
- Connect the AC adapter only to an AC outlet that supplies the rated voltage required by the adapter.
- When disconnecting the AC adapter from the AC outlet, make sure grasp the adapter itself and never pull at the cable.
- During lightning or when not using for an extended period, disconnect the AC adapter from the AC outlet.

[Battery operation]

- Use two conventional size AA-1.5 volt batteries.
- H4n cannot be used for recharging. Pay close attention to the labeling of the batteries to make sure you choose the correct ones.

- When not using for an extended period, remove the batteries from the unit.
- If battery leakage has occurred, wipe the battery compartment and battery terminals carefully to remove all remnant of battery fluid.
- When using the unit, the battery compartment cover should be closed.

Environment



Warning

To prevent unexpected troubles and malfunctions, avoid using H4n in environment where it will be exposed to:

- Extreme temperatures
- Heat sources such as radiators or stoves
- High humidity or moisture
- Excessive dust or sand
- Excessive vibration or shock

Handling



Warning

- Never place any objects filled with liquids, such as a vase, on the H4n since this can cause electric shock.
- Never place naked flame sources, such as lighted candles, on the H4n since this can cause fire.



Caution

- The H4n is a precision instrument. Do not exert undue pressure on the keys and other controls. Take care not to drop, bump, and do not subject it to shock or excessive pressure, which can cause serious troubles.
- Take care that no foreign objects (coins or pins etc.) or liquids (water, alcoholic drinks and juice) can enter the unit.
- Do not place the H4n speaker closer to other precision instruments (watch and computer), electronic medical instruments, or magnetic cards.

Connecting cables and input and output jacks



Caution

You should always turn off the power to the H4n and all other equipment before connecting or disconnecting any cables. Make sure to disconnect all a connection cables and the power cord before moving the H4n.

Alterations



Warning

Never open the case of the H4n or attempt to modify the product in any way since this can result in damage to the unit.

Volume



Caution

Do not use the H4n at a loud volume for a long time since this can cause hearing impairment.

USAGE PRECAUTIONS

Electrical interference

For safety considerations, the H4n has been designed to provide maximum protection against the emission of electromagnetic radiation from inside the device, and protection from external interference. However, the equipment that is very susceptible to interference or that emits powerful electromagnetic waves should not be placed near the H4n, as the possibility of interference cannot be ruled out entirely.

With any type of digital control device, the H4n included, electromagnetic interference can cause malfunctioning and can corrupt or destroy data. Care should be taken to minimize the risk of damage.

Cleaning

Use a soft, dry cloth to clean the H4n. If necessary, slightly moisten the cloth. Do not use abrasive cleanser, wax, or solvents (such as paint thinner or cleaning alcohol), since these may dull the finish or damage the surface.

Please keep this manual in a convenient place for future reference.

Copyright warnings

■ Recording of live performances

Many artists and most live venues do not allow recording and photography and will check for cameras and recorders at the entrance. Even if recording is allowed, it is prohibited to sell, distribute, or upload to the Internet without the organizer's authorization. Copyright violation is a crime.

■ Capturing music and sound files

Saving music to CD, MP3, or other media, reproducing files for personal use can be considered a copyright violation.

Trademarks:

- The SD symbol and SDHC symbol are trademarks.

- The use of MPEG Layer-3 audio compression technology is licensed from Fraunhofer IIS and Sisvel SpA.
- Windows is a registered trademark of US Microsoft Corporation.
- Mac OS and Macintosh is a trademark of Apple Inc.
- Steinberg and Cubase are registered trademarks of Steinberg Media Technologies GmbH Inc.
- Names of manufacturers and products are each respective owner's trademarks or registered.

Getting started

1-1 Recording flow using the H4n

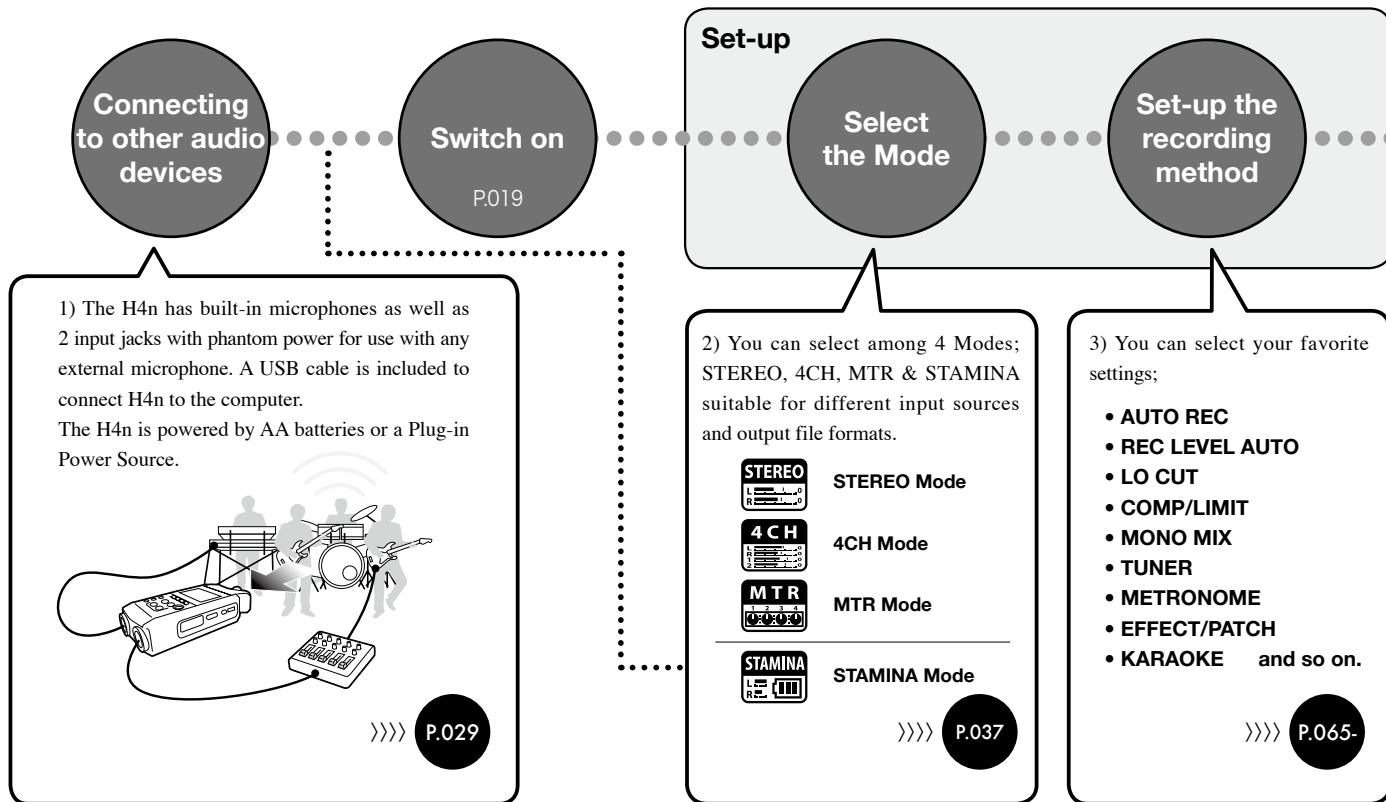
The following is the basic flow of recording operation for the H4n. Depending on the application of the recording, you can select which recording mode and audio quality setting is right for the situation.

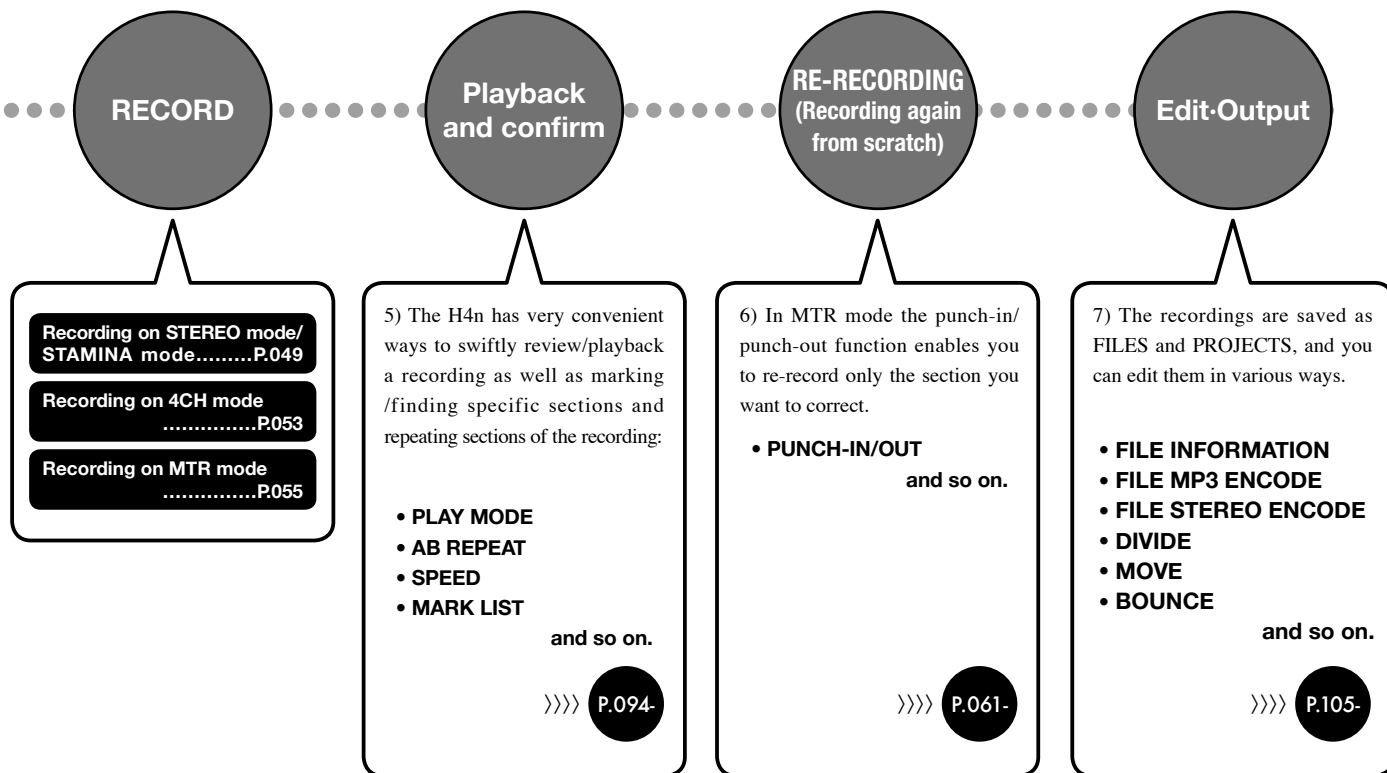



1-2 Easy recording guide [STEREO MODE]

The following is basic recording instructions using the built-in stereo microphones and built-in speaker in STEREO MODE.

1
Power switch ON

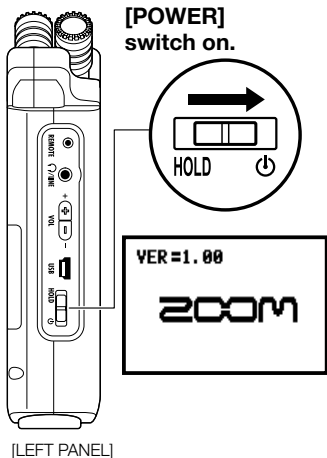

2
Confirm STEREO MODE

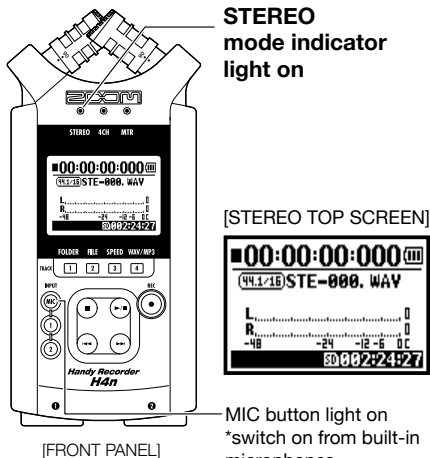

3
RECORD READY OR STANDBY CONDITION

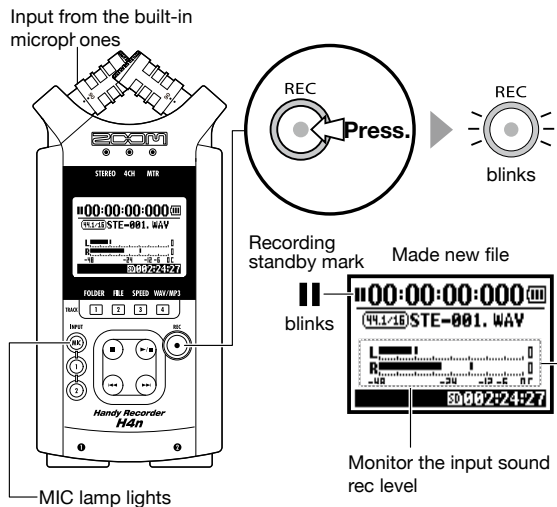

In case of a wrong MODE indicator or a wrong screen >>> **P.038**

Press here when you want to stop.

4
ADJUST
INPUT LEVEL

5
START
RECORDING

6
STOP
RECORDING

7
PLAYBACK

DECREASE INCREASE

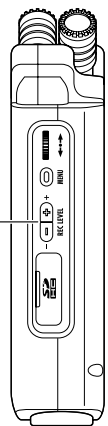
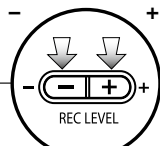

[RIGHT PANEL]



Adjust the input sound
rec level

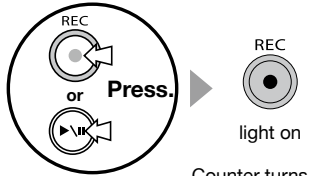

Counter turns



Remaining time on SD CARD

- Pause Recording**
Counter doesn't return 0
- Mark Recording**
Places Mark at specific time in WAV file format

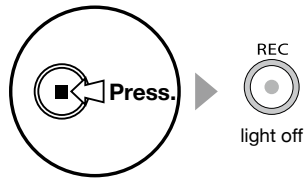

Counter returns 0:00:00:000

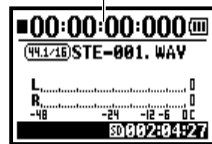

In detail >>> P.049

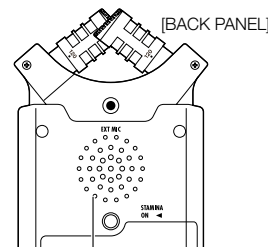
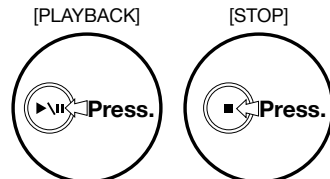

Output: Built-in speaker

In detail >>> P.094

2-1 Name and function of each part

[FRONT PANEL]

90 / 120°
Variable XY
Stereo microphones
(Built-in)

STEREO/4CH/MTR
mode indicator

Backlight Equipped
Display

- Short cut buttons on STEREO/4CH mode
 - [1] <FOLDER>
 - [2] <FILE>
 - [3] <SPEED>*STEREO mode
 - [4] <WAV/MP3>
 - *STEREO/4CH mode

- On MTR mode
Buttons for
TRACK [1], [2], [3], [4]

INPUT: Buttons for
[MIC] [1], [2]

Transport Control Buttons

[REC] Button

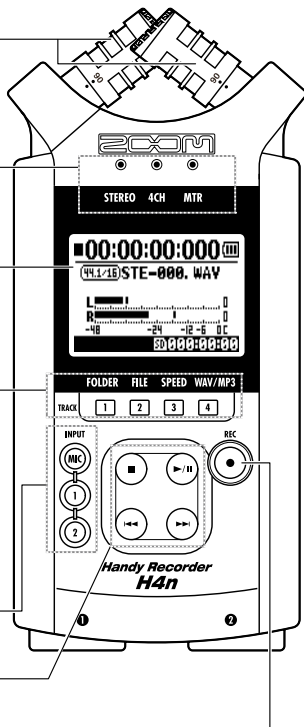

[BACK PANEL]

Input jacks for external stereo
microphone

A built-in mono speaker

Threaded Tripod mount

Battery cover

STAMINA mode
switch

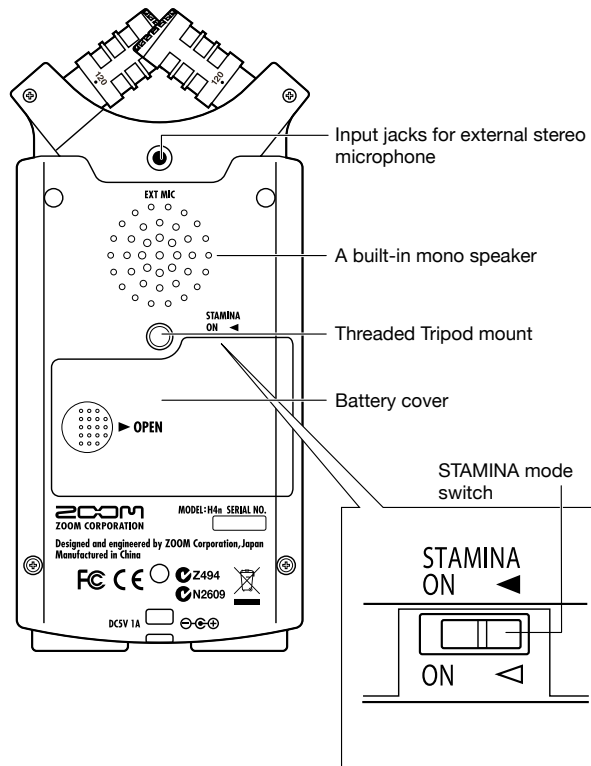

[RIGHT PANEL]

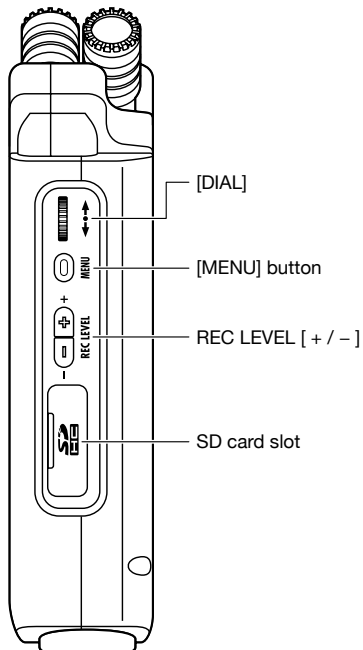

[LEFT PANEL]

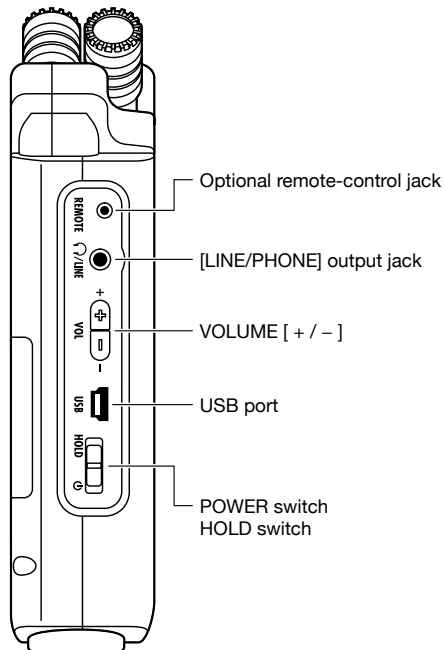

[BOTTOM PANEL]

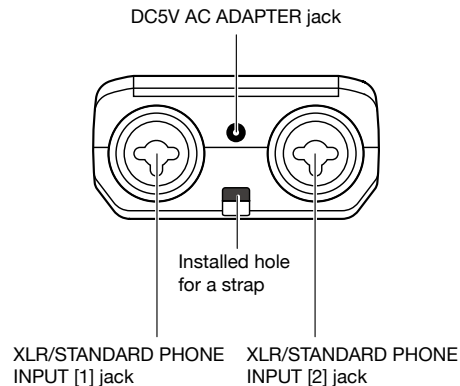

2-2 Included Accessories

The following accessories are included in the H4n package.
Inspect the package contents to be sure all accessories are included.

SD CARD



WINDSHIELD

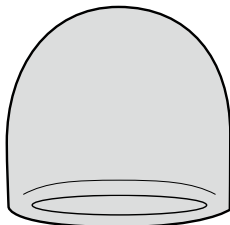

**MICROPHONE STAND
ADAPTER**



**AC ADAPTER
(ZOOM AD-14)**

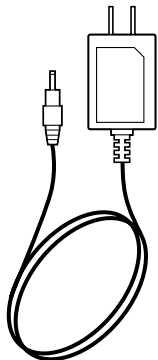

USB CABLE



MAIN BODY CASE

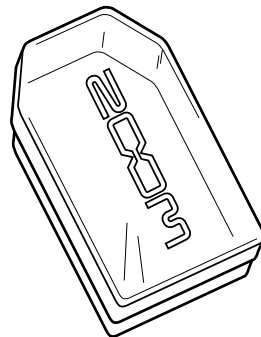

Instruction manual

DAW start-up guide

Cubase LE4

•How to use the windshield



When recording outside in the field, covering the built-in microphones with this windshield, you can reduce wind noise.

•How to mount to a microphone stand

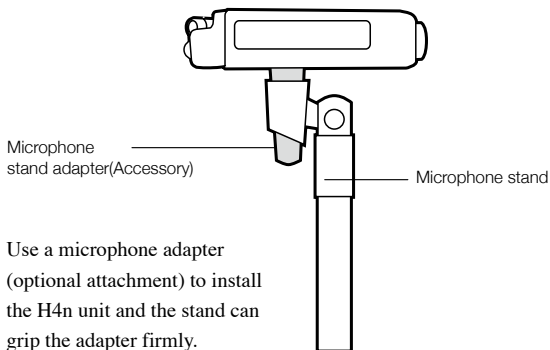

Use a microphone adapter (optional attachment) to install the H4n unit and the stand can grip the adapter firmly.

Remote control
(Option, sold separately)

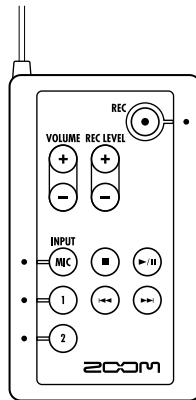
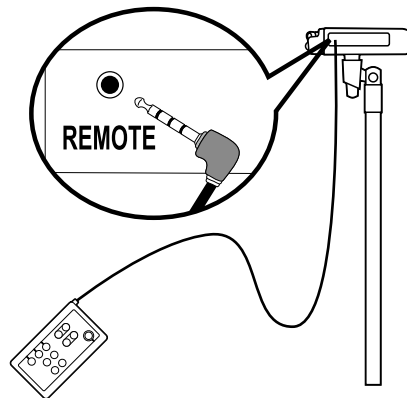

[FRONT PANEL]



[SIDE PANEL]

Operation of remote control >>>>

P.045

3 Battery/Power setting

Power for H4n recorder is supplied by the included AC adapter or batteries.

• AC power operation

An AC adapter is included.

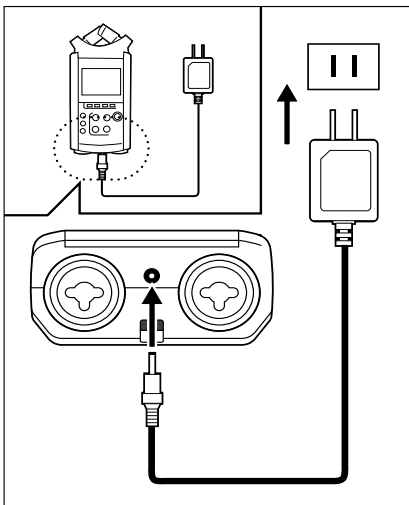

An attached AC adapter
Zoom AD-14

Use of an AC adapter other than the one included may cause trouble.

• Battery installation

Install two size AA batteries (IEC R6)

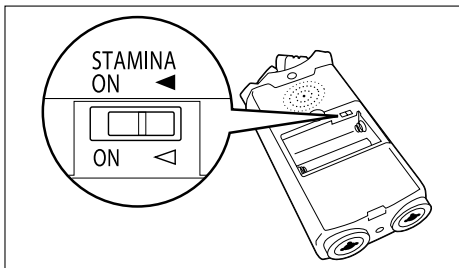
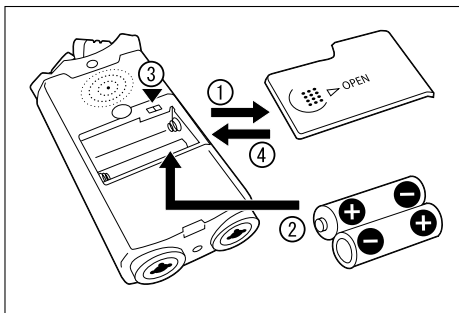

1 Open the battery compartment cover.

NOTE:

Make sure the power is off!

Whenever you open the battery compartment cover or plug in/unplug the AC adapter, make sure the power is off, otherwise the recording data can be destroyed.

2 Insert two size AA batteries ensuring you match the polarity markings (+ and -).

* Illustration : open the battery compartment cover and insert batteries.

3 Set the Stamina Mode Switch.

* Illustration of a Stamina Switch on.

◀ : Use in general (Using AC adapter, batteries)

ON: Stamina Mode On (Eco-power mode when using batteries)

4 Close the battery compartment cover.

* Illustration of closing the battery compartment cover.

Ref. Explanation about the Stamina Mode. [P.037](#)

• **Battery's approximate lifetime**

Alkaline battery	in general use	about 6 hours
	in stamina mode use	about 11 hours

* Approximate lifetime when it is used for continuous recording on WAV 44.1 kHz/16bit format.

• **Remaining lifetime of the battery**

When “Low Battery!” indication appears, immediately switch off unit and exchange batteries, or shift power source to AC adapter.

When remaining battery life is getting short, “Low Battery” indication will be shown every two seconds and the power will switch off shortly after.

NOTE:

Usable batteries

You can use conventional alkaline and nickel metal hydride batteries.

Power supply from USB

Connect the USB cable to the H4n while it's already connected to the computer with the power switch off, and power is automatically turned on via USB bus power supply. This function is only available when the H4n is used as an SD card reader or an audio interface.

HINT:

To measure the lifetime of the battery

The remaining lifetime of the battery is measured more precisely by using the battery type setting on the H4n.

Saving period for the setting <DATE/TIME>

Whenever power supply is off by dead battery, the H4n can save the date/time setting for three minutes. When the saving time is over, the setting will be returned to the default value.

Screen indicator for power



Using batteries

Using AC adapter

Ref. <USB BUS POWER> **P.033**
Ref. <BATTERY TYPE> **P.128**

4-1 Power On and Off, How to use power and hold switch

[LEFT PANEL]

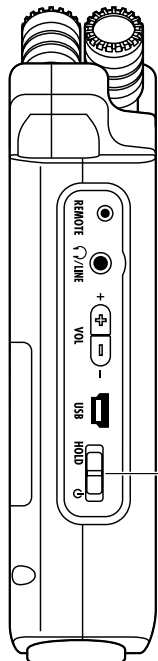

POWER switch
HOLD switch

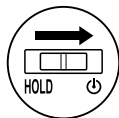

POWER ON / BOOTING UP

1 [Preparation]
Make sure all equipment is turned off.

2 Insert SD card.

3 [Power On _ Boot up]
Slide the power switch.



4 Switch on connected instruments and monitors.

NOTE

- Before switching the power on, lower the volume of instruments and monitors connected to the H4n.
- If the display reads "No Card" when booting up, make sure that the SD card is inserted correctly.
- If the display says "Reset DATE/TIME" when booting up, the date and time are set to the primary value.

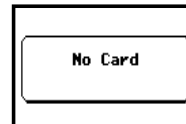

Ref. **P.028**
<DATA/TIME>

HINT: Procedure for power on.

When using additional audio devices, power them on in the following order:



POWER OFF / SHUT DOWN

- [Preparation]**
Turn off monitors first then instruments

- [Power Off _ Shut down]**
Slide the power switch.

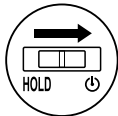

* shut down screen

HINT Procedure for power off

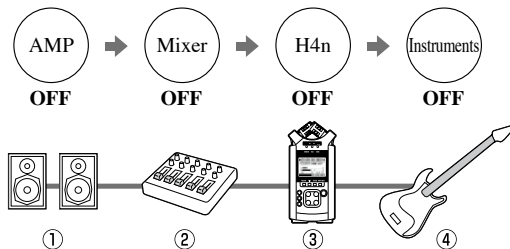

HOLD Function

.....
The H4n features a HOLD function to make any button operation inactive, preventing errors during recording.

To engage the hold function,
slide switch to hold position.

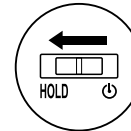

* 'Key Hold' display

If you press any button while the HOLD function is engaged, the screen will display "Key Hold" for two seconds. To disengage the HOLD mode, slide power switch out of hold position.

4-2 How to use the [REC] and transport control buttons

Buttons like [REC], [STOP], [PLAY/PAUSE], [FF], [REW] each have different functions depending on the H4n's operation MODE.

[FRONT PANEL]

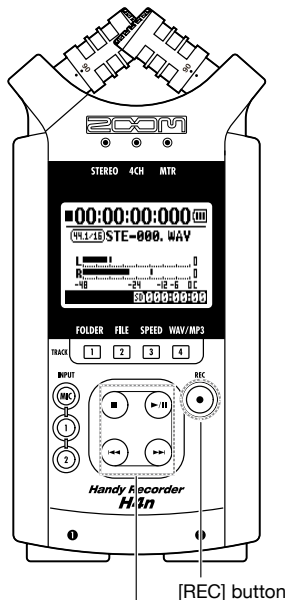

[REC] button
transport control buttons

STEREO/4CH/STAMINA MODE

REC [REC] button

Stop Enter recording standby mode and reset the counter to 0

Recording Standby Start recording and counter

Record Playback Place a mark (WAV FILE only)

TRANSPORT CONTROL BUTTONS

[STOP] button

Recording, recording standby, Recording-pause Stop recording and reset counter

Playback-pause Stop playback and counter

[PLAY/PAUSE] button

Stop Start playback and counter

Recording, Recording-pause Pause or restart recording

recording standby Start recording and counter

Playback-pause Pause or restart playback

[FF], [REW] buttons

Stop Press for less than one second
[FF] move to next file
[REW] returns to the beginning of the file
* However if there is a marker in a WAV file, the button moves to the marking place.

Playback Press for more than one second

Playback-pause Scans through file in forward or reverse direction.

The longer the button is pressed, the faster the scanning speed. Fast Forward or Rewind will stop at the beginning or end of the file.

MTR MODE

REC [REC] button

Set to overwrite recording

Stop Engages recording standby mode

Record, Recording Standby Stop recording (You can continue playback while recording)

Playback Stops recording and resets the counter

Recording in ALWAYS NEW mode

Stop Stops recording and counter

Recording Standby Starts recording and counter

TRANSPORT CONTROL BUTTONS

[STOP] button

Recording Stop recording and the counter stops

Playback Stop playback and the counter stops

Recording-pause Playback-pause Stop each movement

[PLAY/PAUSE] button

Stop Starts playback

Recording In OVERWRITE mode: No function
In ALWAYS NEW mode: pause recording

Recording standby Starts recording and counter

Playback Pause Playback

[FF] [REW] buttons

Stop Press for less than one second

Playback [FF] : Moves forward through file in one second increments
[REW] : Returns to the beginning of the file

Playback-pause Press for more than one second
Scans through file in forward or reverse direction.

4-3 How to use the track [1], [2], [3] and [4] buttons

The buttons of TRACK [1] – [4] have different functions depending on the MODE.

[Front Panel]

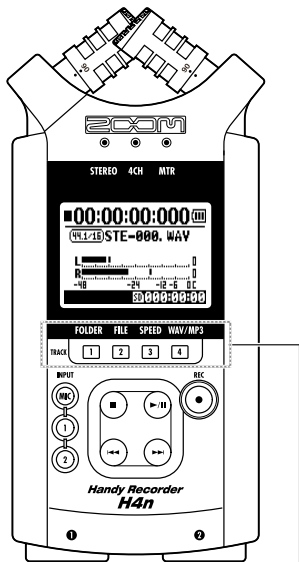

TRACK [1]-[4]

MTR MODE

Switch from 'RECORDING' to 'PLAYBACK' of the tracks, or the other way around



When you start recording, press the track number you want to record and the track becomes 'Recording Standby' status. That track button will then become illuminated.

Make settings of the track and the input source

After selecting the track, use the input source buttons to select the input for that track. Using the INPUT button you can record in mono, stereo or a combination of those.

Select only one track

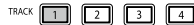

* track #2-#4 are the same, press the number you select

Select two tracks



* track #3 and #4 are the same

For stereo input you select from [MIC] and [1] [2]

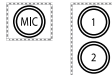

For a mono input you can select either from [1] or [2]



* Input selections are those four different combinations.

* Those operations are not valid during recording and playback.

STEREO/4CH/STAMINA MODE

1 Move to the <FOLDER SELECT> menu

2 Move to the <FILE> menu

3 Move to the <SPEED> menu (only STEREO MODE)

4 Move to the <REC FORMAT> menu (STEREO MODE, 4CH MODE)

These operations are not available during recording and playback.

4-4 How to use the input [MIC], [1] and [2] buttons

These buttons have different functions depending on the various modes.

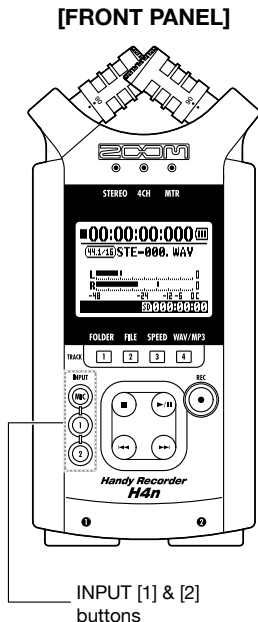

STEREO/STAMINA MODE

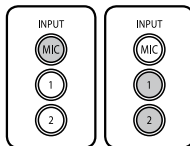

Select INPUT [MIC] or INPUT [1] [2] and the corresponding button lights up.

Whether you select the INPUT [1] or INPUT [2] button, they will both respond the same. Both buttons light up after the selection. (Once lighted the buttons do not respond)

Any other settings about input sources like [REC LEVEL], should be made to the lighted target.

* When the presently selected input clips its button will blink.

4CH MODE

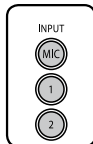

Use all input sources like [MIC], [1] and [2] = All [MIC], [1] and [2] light on.

When you switch to 4CH, H4n will receive 2- system stereo inputs from [MIC] and [1] [2] altogether. When you press the lighted button, each shows its input level and you can make adjustment to recording level operating [REC LEVEL].

* When the input clips the corresponding button blinks.

MTR MODE

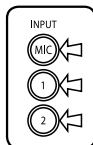

Select [MIC], [1] and [2] individually and the corresponding button lights up.

You can select individually INPUT [MIC], [1] and [2]

- When you use built-in and the external stereo microphones, select INPUT [MIC].
- When you make stereo input using the external input jack, select both INPUT [1] and [2]. You press either INPUT [1] or [2] button and then press another button.

* When the selected input clips its button blinks.

HINT:

What is clipping?

The input level reaches up to the maximum which the H4n can record, that is 0 dB.

In this case the recording sound can be distorted and need adjustment of recording level.

4-5 How to use REC LEVEL and VOLUME

These keys allow you to adjust the levels of recording input and output volume.
 (All the modes are the same)

[LEFT PANEL]

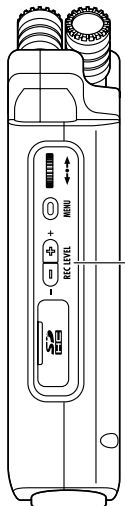

REC LEVEL

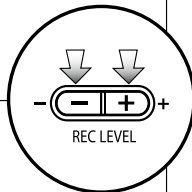

'REC LEVEL' IN ANY MODE

The recording levels coming from the INPUT [1] & [2] can be adjusted from 1 to 100 with the (+/-) key.

Press the 'REC LEVEL' = Adjusting

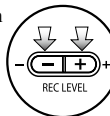

- INPUT
- (MIC)
 - (1)
 - (2)

Target setting:
 Press INPUT [MIC], [1] and [2] buttons and select the input source which you want to adjust the recording level.

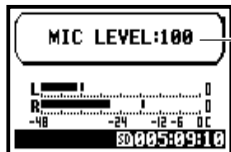

1 _ 100
 + : Increase reception level (amplify)
 - : Decrease reception level (reduce)

[RIGHT PANEL]

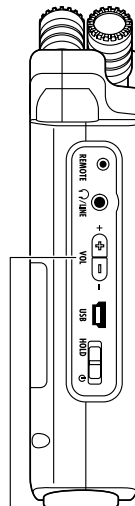

VOLUME

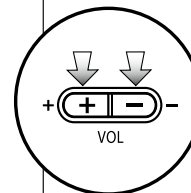

[VOLUME] IN ANY MODE

Press the 'VOL' = Adjusting

Output volume from the built-in speaker and output jacks can be adjusted from 0 to 100 with the (+/-) key.

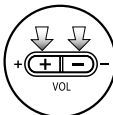

0 _ 100
 + : Increase Volume
 - : Decrease Volume

4-6 How to use [DIAL] and [MENU] buttons

[DIAL] and [MENU] buttons are used for various settings while recording and during playback.

Here are some basic explanations about each operation.

[RIGHT PANEL]

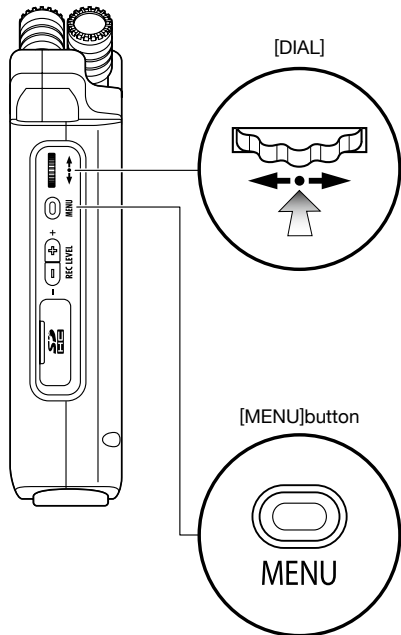

The basic operation for [DIAL]



Rotate the [DIAL] = select an item

Rotate the [DIAL], and the cursor on the display will move along the [DIAL]

Select



Press in the [DIAL] = confirm the selection

Press down [DIAL], your selection is confirmed.

→ for additional selections, move on to the next screen.

→ When you complete selections, the screen returns back to the previous one.

Press

The basic operation for [MENU] button

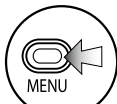

Calling [MENU] screen

When setting recording or playback method, Press [MENU] button at the top screen of each mode.

Select

Canceling the setting



If you press the [MENU] button during any setting operation, its operation will be canceled and the screen returns back to the previous one.

To cancel setting operation and to return back to the top screen of the each mode, press [MENU] button for more than 2 seconds.

Long Press

The operation when [] cursor is on display (Date-Time Setting, Changing File Name Directory, etc)



When you rotate the [DIAL], [] moves accordingly.

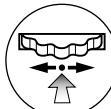

Pressing [DIAL] in, change the numbers and letters.



The item letters or numbers are reversed → Rotate [DIAL] to change the numbers and letters → Press [DIAL] down to confirm your selection.

[DIAL] operation on the top screen



Moving [DIAL] on the top screen, 'cursor' moves. Pressing (highlight) [] selects 'COUNTER' to enable adjustment or calls up the setting menu.

* Available only on MTR mode.

The operation when the selections are listed on screen



By rotating the [DIAL], the selection lists will move accordingly.

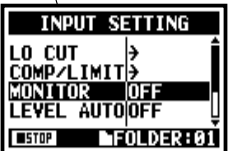

Push [DIAL] in, to confirm your selection.



the screen returns back to the previous one.



About the '□' on the selection lists



When you see this display, there are more selections on the next screen. Highlight arrow and press [DIAL] in to move on to the next screen.

5-1 Insert a SD card

The SD card is required to record. Make sure to turn off power before inserting or removing the SD card.

[How to install the SD card]

1 Make sure power is off.

2 Insert the SD card into the slot.

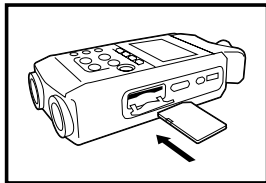

[How to remove the SD card]

1 Make sure power is off.

2 Push the SD card in to remove it from the slot.

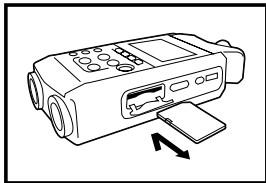

SD card capacity time to record (approx.)

4GB SDHC card	Recording time
WAV 44.1 kHz/16 bits (measured in terms of stereo track)	approx. 380 minutes
MP3 44.1 kHz/128 kbps (measured in terms of stereo track)	approx. 68 hours

NOTE:

POWER OFF !

Never insert or remove the SD card while the power is on. This may destroy the data.

CAUTIONS WHEN INSERTING SD CARD

- You can use 16MB to 32GB SD cards. For a list of operation certified SD cards please refer to ZOOM's website: <http://www.zoom.co.jp/>
- When you use the SD card for your computer, digital camera or other machine, formatting in the H4n is required.
- When "No Card" is seen on the display at boot-up, check if the SD card is correctly inserted.
- When "Format Card" is seen on the display at booting-up, this means the SD card has not been formatted in the H4n. To format, press [DIAL] down and select OK button.
- When the booting-up screen says "Card Protect", the card is covered with OVERWRITE PROTECT. To release this protect slide the lock switch of the SD card.

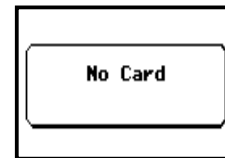

"Warning" no SD card in when booting - up.

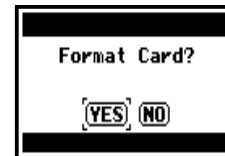

This "Warning" will show when an SD card is not in a recognized format. Select <YES> to format card and all of the data will be deleted.

5-2 Set date and time <DATE/TIME>

Each file will automatically record the date/time.

To facilitate searching for files by date, be sure to set the date/time after every battery change.

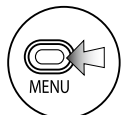

1 Press.



2 Select <SYSTEM> and press.

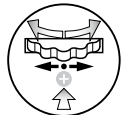
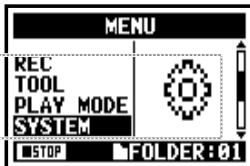

3 Select <DATE/TIME> and press.



5 Select <OK> and press.



4 Set YEAR→MONTH→DAY→TIME
(Time: Minute: Second)

Select the item on <DATE/TIME>:



You can select the item while moving [] of the [DIAL].

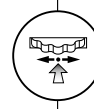

Press the [DIAL] in

* The selected item values are highlighted.

[Change the figure number]:



You can select the number by rotating the [DIAL].



Press the [DIAL] in

* [] comes out on display.

NOTE:

When "Reset DATE/TIME" is seen during boot-up, the date/time needs to be set.



- When there is no power source connected for more than three minutes, the DATE/TIME setting will return to the default value.
- You cannot use this setting during recording and playback.

6-1 Setting up: How to connect external audio devices

The H4n offers versatile connectivity with options for any recording application.

Remote control
(option)

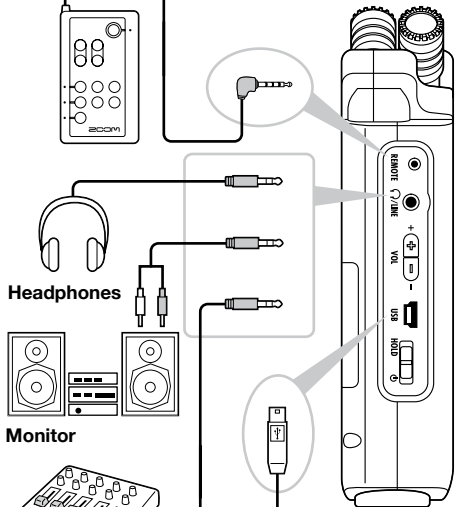
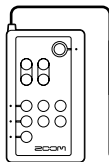

Headphones

Monitor

Mixer

USB

Personal computer (PC)

INPUT: instrument
(guitar)

H4n's very own AC adapter

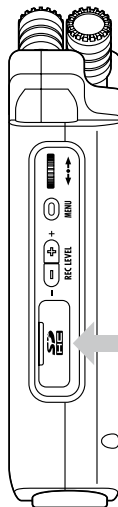
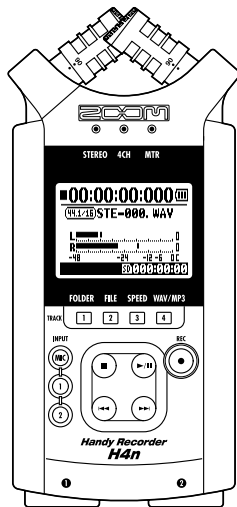

Stereo
microphones

SD card

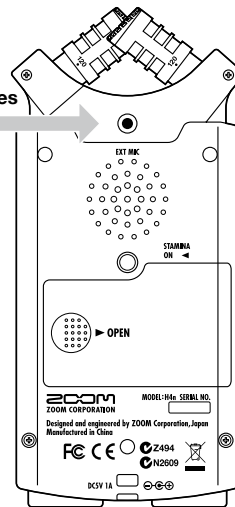

INPUT: instrument
(keyboard)

INPUT: instrument
(microphone)

6-2 Setting up: Built-in microphones

These are special features of the H4n's built-in microphones.

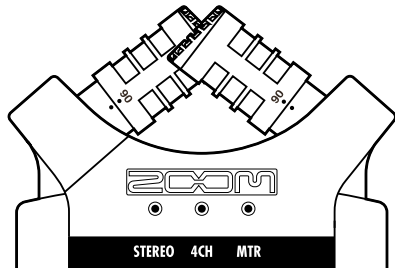

High quality microphones in an XY pattern ensure a natural stereo image when recording sounds.

Stereo recording is often done by placing two microphones in a V shape. Pointing microphones outward will result in stereo separation, however the recording will lack definition around the center position, resulting in a poor stereo image.

The H4n utilizes an X Y stereo mic configuration. By placing two microphones in a crossed pattern (opposing angles), the H4n can cover a wide area and capture sound sources in the center with clarity and definition. Sounds reach both mics simultaneously, and therefore no phase cancellation occurs between right and left channels.

LOCATION OF THE MICROPHONES UNDER XY SYSTEM

Capturing sound in a stereo image.

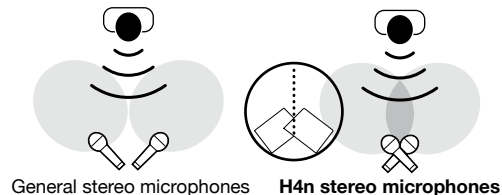

Stereo images with no phase cancellation.

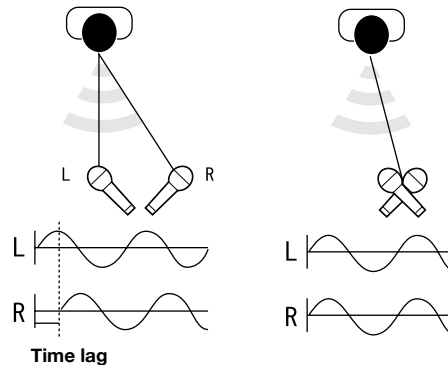

General stereo microphones H4n stereo microphones

DIRECTIVITY OF 90°, 120°

Center 90°

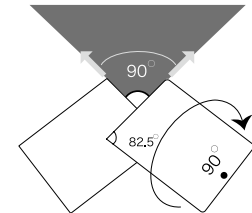

movable

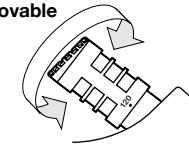

Width 120°

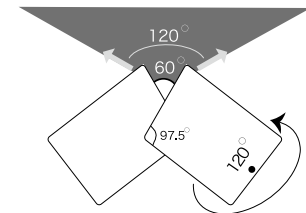

6-3 Setting up: Built-in microphones /outside microphone with plug-in power

The input jack for the external microphone is suitable for microphones that require <PLUG-IN> power.

Close microphone recording

Please put H4n 30 - 50 cm away from the sound source.

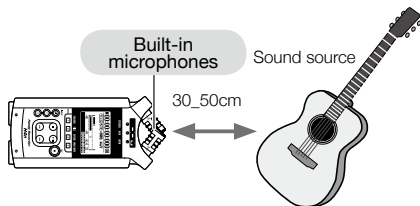

Off microphone recording

Make sure the recording sound sources are all located in the range of T zone of the Built-in microphones.

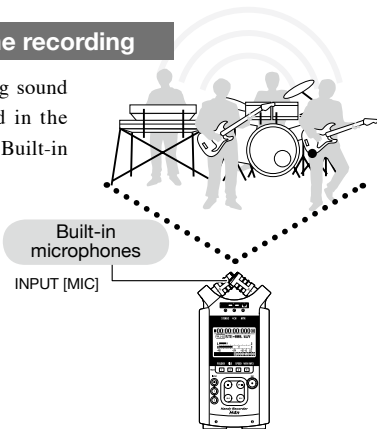

External microphone recording

When you use the external microphone, be sure to select the correct setting.

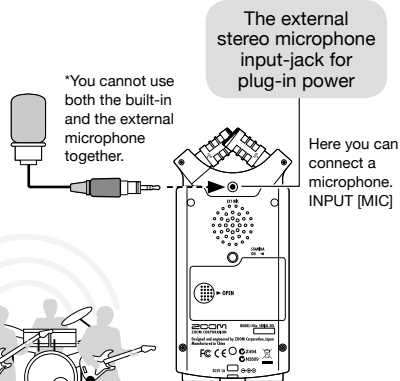

NOTE:

Plug-in and phantom power can not be set during recording and playback.

[How to make setting of <PLUG-IN> power]

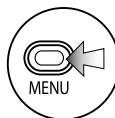

1
Press.

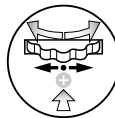

2
Select <INPUT> and press.

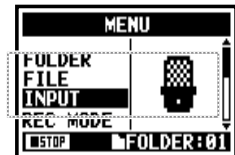

3
Select <PLUG-IN> and press.



4
Select <ON> and press.

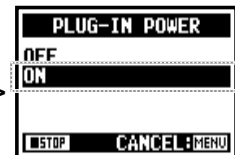

6-4 Setting up: INPUT [1], [2] connections and phantom power source

Using INPUT [1] and INPUT [2] you can connect to a guitar, a bass, a keyboard, etc.

Connecting to instruments

For a guitar or a bass, you can directly plug into either INPUT [1] or INPUT [2].

For a keyboard with stereo output, you can plug into both the INPUT [1] and the INPUT [2].

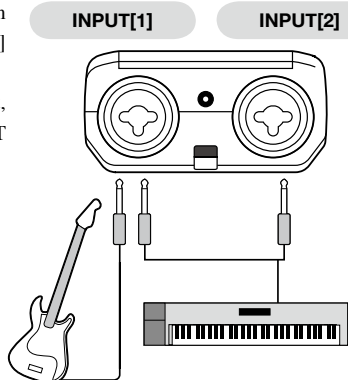

Connecting to a microphone

To connect a microphone you connect XLR plugs to INPUT [1] and INPUT [2]. In case you need phantom power, such as using a condenser microphone, be sure to select the following setting.



Dynamic microphone



Condenser microphone
*for phantom power

NOTE:

Some condenser microphones cannot operate with +24V phantom power, but comparing to +48V setting this function is useful for battery operation to economize electric consumption.

[How to make setting of <PHANTOM> power]

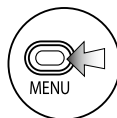

1 Press.



2 Select <INPUT> and press.

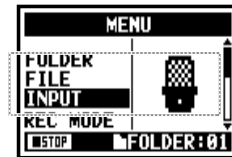

3 Select <PHANTOM> and press.



4 Select the voltage and press.



6-5 Setting up: USB connection, H4n used as an Audio Interface

The H4n can be used as a two-in/two-out USB interface at 44.1kHz or 48kHz.

From power ON

Connect H4n to computer with USB cable.

From power OFF

- 1 Connect H4n to computer with USB cable.

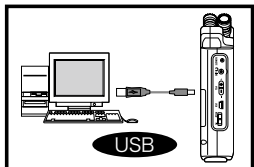

- 2 Press on the top screen.

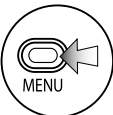

- 3 Select <USB> and press.

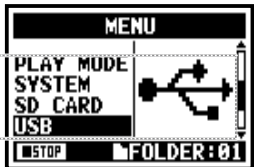

- 5 Select <FREQUENCY> and press.

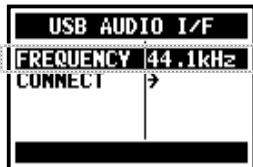

- 6 Select a sampling rate and press.

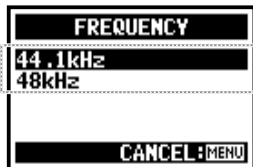

- 7 Select <CONNECT> and press.



displayed input or output level

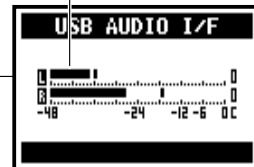

Two channels can be sent and received while it connects a computer and by using of 44.1kHz or 48 kHz.



displayed a active function

Ref.

<EFFECT>	P.083
<TUNER>	P.075
<MONITOR>	P.071
<PHANTOM>	P.032
<PLUG-IN>	P.031

Using USB bus power, H4n start booting-up
Display of USB setting screen



- 4 Select <AUDIO I/F> and press.

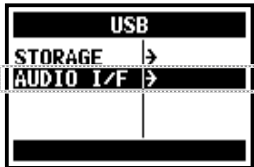

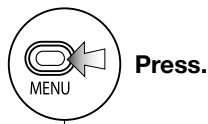
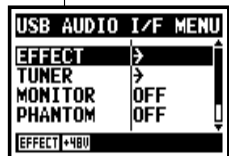
[Button operation during setting and <AUDIO I/F> menu]**Press.****<AUDIO I/F> MENU**

EFFECT	Use EFFECT (only on 44.1 kHz)
TUNER	Use TUNER
MONITOR	Use MONITOR
PHANTOM	Use PHANTOM power
PLUG-IN	Use PLUG-IN power
DISCONNECT	Disconnect

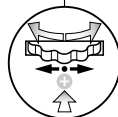
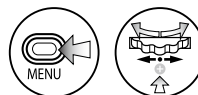
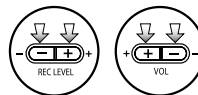
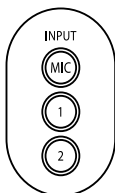
**Select and press.****[You can use those buttons during setting]***** Call [MENU] and make setting***** Adjust input / output level****[Selection of input source]**

When you select an input the corresponding input button lights, confirming the selection. To turn off the input, press the corresponding input button and the light will turn off.

* When no input is selected and no input buttons are lit, you are sending no signal to the computer.

To monitor input signals, you must turn the <MONITOR> setting on.

NOTE:

- You cannot change a sampling rate while computer is recognizing H4n as an audio interface.
- To connect as an Audio I/F, make sure that a sampling rate (step 6) matches the recording software and playback file.
- You cannot use this setting during recording and playback.

HINT:**Usage of AUDIO INTERFACE**

- You can record and playback signals directly to and from your DAW software using the H4n.
- In this mode, you can use the H4n's built-in effects on input signals.
- Effects can only be used when the sampling rate is set to 44.1kHz.
- You do not need a specific driver to use the H4n as an USB audio interface.
- When using a specific DAW, please refer to its respective user manual.

6-6 Setting up: USB connection, H4n used as a SD card reader

When you use the H4n as a SD card reader, make the following settings.

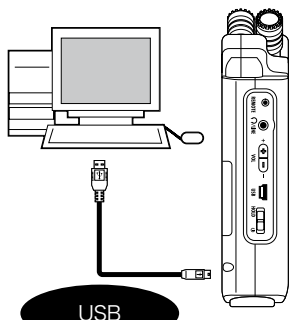

From power ON

1 After it's powered 'ON', connect the H4n to the computer with the USB cable.

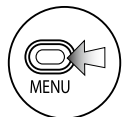

2 Press on the top screen.

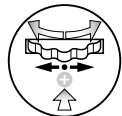

3 Select <USB> and press.

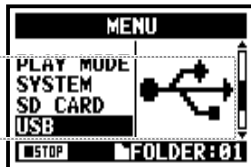

Connect H4n to computer with USB cable.

Using USB bus power, H4n start booting-up
Display of USB setting screen

From power OFF

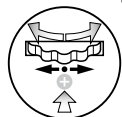

4 Select <STORAGE> and press.

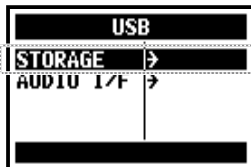

connection completed

NOTE:

- Before physically unplugging USB cable (and H4n) from computer, be sure to perform the “safely remove hardware” function on the computer first. Unplugging USB cable (and H4n) without performing this function may damage files.
- Compatible operating system
Windows XP
Mac OS X (10.2 or later)

HINT:

USB bus power

USB bus power is the method to supply power from a computer through the USB cable.

Connecting USB with the H4n power off condition, H4n automatically boots up and displays USB menu.

Usage of a SD card reader

- You can use files recorded on the H4n on your computer.
- The H4n can use audio files created on your computer.

6-7 Setting up: Built-in speaker

The H4n is equipped with a built-in mono speaker.

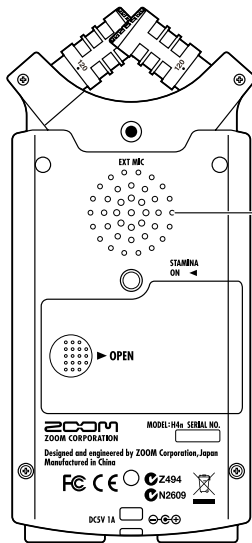

H4n built-in speaker

This is a mono speaker for playback. Without connecting headphones to [LINE/PHONE] jack, you can easily playback the recorded data and listen.

NOTE:

There is no output when [LINE/PHONE] jack is plugged in. When setting is the <MONITOR>, there is no output of the input signals. The built-in speaker cannot be used when recording in standby on MTR mode.

HINT:

When you can use this function:

- The FILE playback
- Using as <AUDIO I/F>.
- Nothing connected to the [LINE/PHONE] jack.

7-1 About H4n modes

There are four operational modes in H4n: STEREO/STAMINA, 4 CH (CHANNEL), MTR (MULTI TRACK) mode. You can choose the mode according to your need.

• STEREO mode

You can easily create a stereo recording via the built-in microphones or an external microphone.

The STEREO mode is convenient to record a band's live performance, acoustic instrument, voice, lecture, or a subtle soundscape. you can then transfer the file to a stereo WAV/MP3 recorder/player.

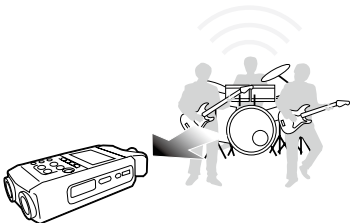

- One-pass stereo recording of live performance or rehearsal.
- Direct recording of a single instrument.
- Field recording.
- Voice memos.
- Record important points during a conference.

• STAMINA mode

This mode allows for longer battery life. STAMINA mode operation is similar to STEREO mode, but with less functions.

Continuous usage time for Alkaline batteries: approximately 11 hours (battery life can be less depending on usage).

When in STAMINA mode, the H4n can only record/playback in WAV 44.1kHz/16-bit and MP3 format.

When using batteries STAMINA mode can be turned on using the stamina switch before booting up. ▶P.017

- 'Live' outside recording.
- At the conference, or the places difficult to change batteries.

• 4CH mode

In 4Ch mode, you can record two stereo signals simultaneously. You can capture both live sounds via built-in mics and direct instruments via external inputs simultaneously.

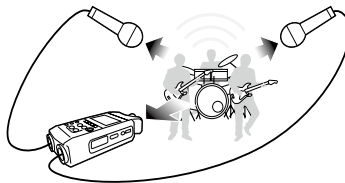

- Simultaneous recording with both line input and a microphone.
- Surround recording via front and rear microphone placement.
- Simultaneous recording of both ambient and direct sound sources.
- Record both ambient and direct sounds to add a live feel to recorded performances.

• MTR mode

You can record using effects. You can also overdub recordings and use sound files previously recorded using the H4n's other modes.

When creating a demo, you can record backing tracks at home and record instrumental tracks at the studio while listening to the backing tracks.

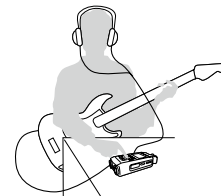

- Record one track at a time and then combine them.
- Overdubbing.
- Record using effects
- Mixing track levels after recording.
- Indoor or outdoor rehearsals.

7-2 Selecting a <MODE>

Be sure to select the appropriate mode for your application.

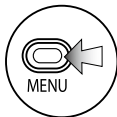

1 Press.

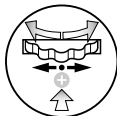

2 Select <MODE> and press.

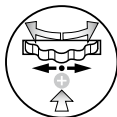
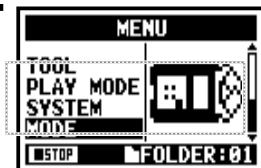

3 Select among STEREO, 4CH and MTR modes and press.

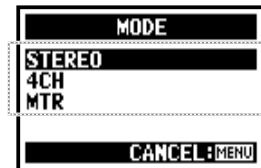

*To engage STAMINA mode, use the switch located in the battery compartment.

HINT:

Confirmation of the mode

- The current mode is indicated on the FRONT PANEL by Mode Indicator LEDs.
- The H4n will power up in the same mode it was in when turned off.
- When booting up for the first time, the default mode is 'STEREO'.

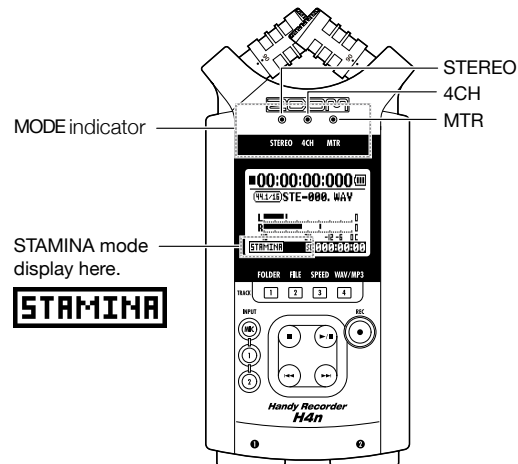

7-3 Details about modes

Input and output levels as well as saving and formatting data are different in each mode.

STEREO mode

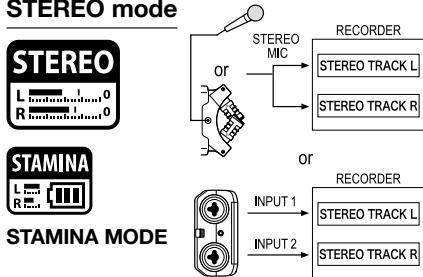

In STEREO mode, you can select 2 different inputs either INPUT[MIC] or INPUT[1] and INPUT[2], and operate them as one stereo file.

The resulting FILE is saved in one of the ten sub-folders of the STEREO folder.

In STAMINA mode, the functions are limited to maximize the battery life time.

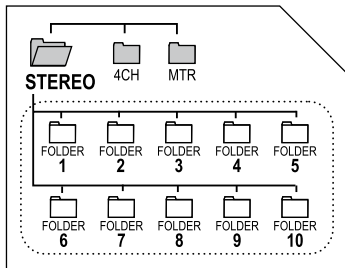

4CH mode

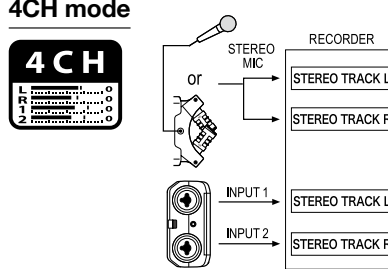

In 4CH MODE the H4n records two stereo WAV files: one stereo WAV file for the built-in microphones and one stereo WAV file for the inputs.

These FILES are saved in one of the ten fixed folders.

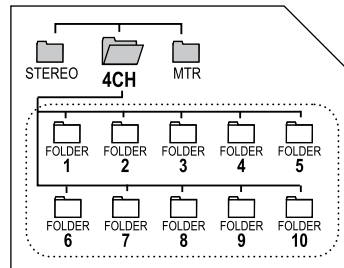

MTR mode

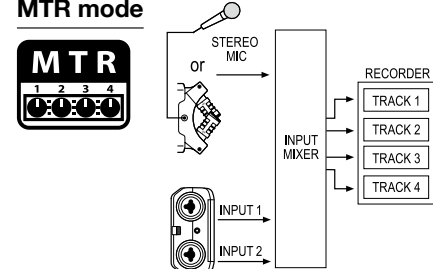

You can record tracks in MONO or STEREO from INPUT [1], INPUT [2] or the internal microphones. You can combine them with tracks recorded in other modes or <OVERDUB> additional tracks.

In MTR mode, project data and settings are saved as a PROJECT in the MTR folder.

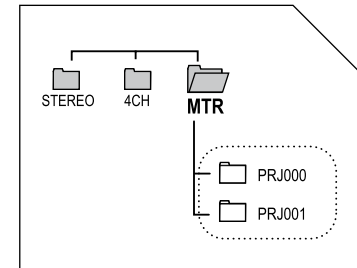

8-1 <MODE> screens: STEREO and STAMINA modes



• Explanation of the top screen

Display of recorder's condition

STOP

Recording Standby **REC**

blink REC [REC] button blinks REC [REC] button lights on

PLAY **PAUSE**

blink blink

FILE FORMAT

File format during selecting, recording and playback.

- WAV FILE: Hz/bit
- MP3 FILE: bit rate

96k24 Display example of 96kHz/24bit

128kbps Display example of MP3 128kbps

STAMINA MODE

Stamina Icon

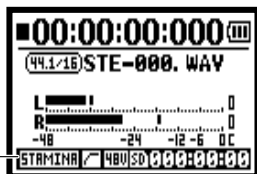

Counter

Recording lapse and playback lapse:
Display: 00(time):00(minute):00(second):000(1/1000second)

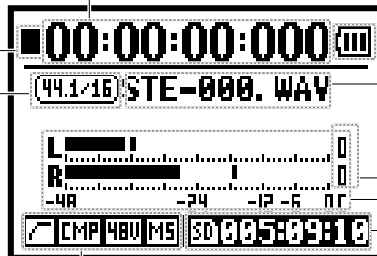

Indicator of option settings: ON or OFF

When each optional function is ON, display says following:

- <LO CUT> function P.068
- COMP** <COMP/LIMIT> function P.069
- 48V** <PHANTOM> power source P.032
48V/24V
- MS** <MS STEREO MATRIX> P.073

REMAINING BATTERY LIFETIME during battery running



When the display of "Low Battery" is shown, it is time to change battery.

FILE NAMES

FILE NAMES during selecting, recording and playback work.

If there is no file in any folder, the screen says 'No Data'.

CLIP METER

The clip meter light turns on when the recording and playback level reach 0dB and remains lit until the file ends or the stop button is pressed.

LEVEL METER

Displays the recording and playback level.

REMAINING RECORDING TIME

Remaining recording capacity time on SD card.

8-2 <MODE> screen: 4CH mode



• Explanation of the top screen

Display of recorder's condition

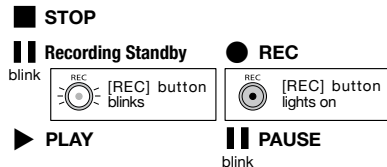

FILE FORMAT

File format during selecting, recording and playback.

Indicator of option settings: ON or OFF

When each optional function is ON, display says following:

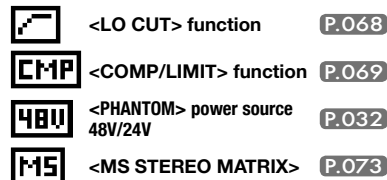

Counter

Recording lapse and playback lapse:
 Display: 00(time):00(minute):00(second):000(1/1000second)

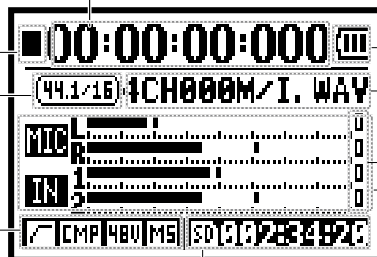

REMAINING RECORDING TIME

Remaining recording capacity time on SD card.

REMAINING BATTERY LIFETIME during battery running



FILE NAMES

FILE NAMES during selecting, recording and playback work.
 If there is no file in any folder, the screen says 'No Data'.

CLIP METER

The clip meter light turns on when the recording and playback level reach 0dB and remains lit until the file ends or the stop button is pressed.

INPUT SOURCE and LEVEL METER

Displays the recording and playback level corresponding to each input source.
 [MIC]Input from either the built-in microphones or an external stereo microphone
 [IN]Input from INPUT [1] and INPUT [2]

8-3 <MODE> screen: MTR mode



• Explanation of the top screen

[DIAL] operations on the top screen



Display of recorder's condition

STOP
 blink only when recording [ALWAYS NEW] setting

REC
 [REC] button lights on

Recording Standby
 blink only when recording [ALWAYS NEW] setting

[REC] button blinks
 [REC] button blinks

PAUSE
 blink only when recording <ALWAYS NEW> setting

PLAY

TRACK NUMBER

During recording standby operation the track or its icon is highlighted.

② TRACK MENU ICON

This is where track settings like 'volume,' 'pan,' 'stereo or mono' are made. Selecting this icon with the jog dial will access the track menu.

P.059

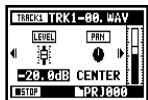

LEVEL METER

This displays the recording and playback level corresponding to each track 1-4.

① Counter

Recording lapse and playback lapse:
 Display: 00(time):00(minute):00(second):000(1/1000second)

Counter Function: Ref. P.102
 Appoint time

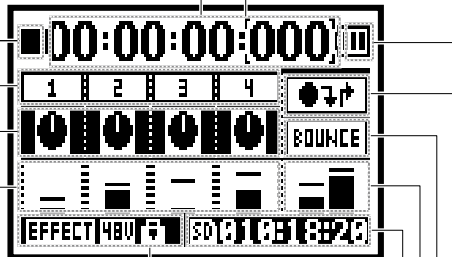

REMAINING BATTERY LIFETIME during battery running

When the display of "Low Battery" is shown, it is time to change battery.

Indicator of option settings: ON or OFF

When each optional function is ON, display says following:

EFFECT <EFFECT> function P.081
48U <PHANTOM> power source P.032 48V/24V
PROTECT <PROTECT> function P.125

③ AUTO PUNCH IN and AUTO PUNCH OUT ICONS

Selecting this icon brings up the PUNCH IN/ PUNCH OUT settings.
 The icon only appears when recording in OVERWRITE mode. P.058

④ BOUNCE ICON

Selecting this icon brings up BOUNCE settings. P.123

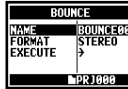

REMAINING RECORDING TIME

Remaining recording capacity time on SD card.

L R LEVEL METER

Displays the master left and right output levels

8-4 <MODE> screen: MAIN MENU

The Menu icon list is displayed by [MENU] button.

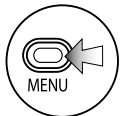

1 Press.

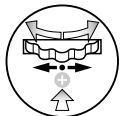

2 Select items and press.

CANCEL:
To return back to the top, press [MENU] button more than 2 seconds.



STEREO mode

<FOLDER>



<FILE>



<INPUT>



<REC>



<TOOL>



STAMINA mode

<FOLDER>



<FILE>



<INPUT>



<REC>



4CH mode

<FOLDER>



<FILE>



<INPUT>



<REC>



<TOOL>

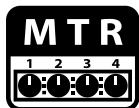

MTR mode

<PROJECT>



<FILE>



<EFFECT>



<INPUT>



<REC MODE>



<PLAY MODE> **<SYSTEM>** **<SD CARD>** **<USB>** **<MODE>**

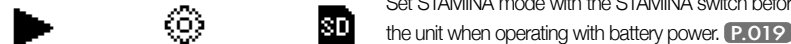

Set STAMINA mode with the STAMINA switch before starting the unit when operating with battery power. **P.019**

<MIXER> **<PLAY MODE>** **<SYSTEM>** **<SD CARD>** **<USB>** **<MODE>**



<TOOL> **<SYSTEM>** **<SD CARD>** **<USB>** **<MODE>**



Display at the bottom of Menu screen



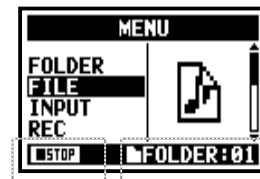



In the recording and playback menu, the current recording condition is displayed at the bottom left of the screen.



On the right bottom of the screen the current folder number is displayed (On Stereo, 4ch and Stamina mode).



In MTR mode, the current project name is displayed.

-  **STOP** Stop
-  **PAUSE** Pause (playback)
-  **PLAY** Playback
-  **REC** Recording Standby / Pause
-  **REC** Recording Standby
On MTR mode and recording on OVERWRITE
-  **REC** Recording

9 Option: Remote control operation

When you use the optional remote controller, you can operate the H4n from a distance.

Remote control button operation

VOLUME [+/–]

0-100
 +: increase (higher)
 -: decrease (lower)

INPUT buttons, [MIC] [1] [2] AND INDICATORS (green, yellow, red)

Select the input source
 * the indicator corresponding to the button shows input condition.
 Green : The input source selected
 Yellow : The level of the input is over -6dB.
 Red : The input is clipping

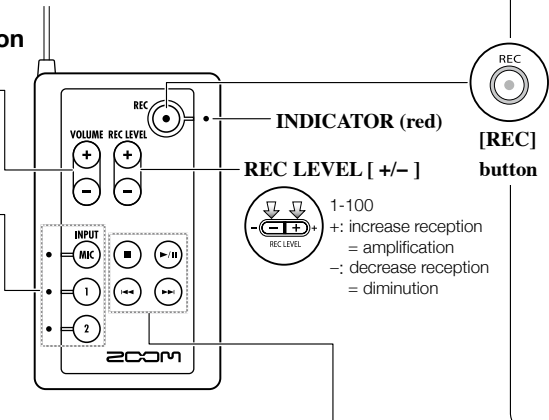

Recording and placing marks.

STEREO	Stop	Engages recording standby condition and counter resets to 0.
4 CH	Recording Standby	Start recording and the counter begins to move
STAMINA	Recording Playback	Place a mark (only for WAV FILE)

* This can be used only when the recording standby track available.

MTR	Set to overwrite recording	
Stop	Engage recording standby condition	
Record, Recording Standby	Stop recording (You can continue playback while recording)	
Playback	Starts recording and sets the counter to 0	
Set always new recording		
Stop	Stop recording and the counter stops	
Recording Standby	Start recording and the counter begins to move	

LOCATOR buttons

[FF], [REW] buttons

STEREO	Stop	Press for less than one second
4 CH	Playback	[FF] move to next file [REW] returns to the beginning of the file However if there is a marker in a WAV file, the button moves to the marking place.
STAMINA	Playback temporary stop	Press for more than one second
		Scans through file in forward or reverse direction. The longer the button is pressed, the faster the scanning speed. Fast Forward or Rewind will stop at the beginning or end of the file.
MTR	Stop	Press for less than one second
	Playback	[FF]: Moves forward through file in one second increments [REW]: Returns to the beginning of the file
	Playback temporary stop	Press for more than one second
		Scans through file in forward or reverse direction.

[STOP] button

STEREO	Record, Recording Standby, Temporary stop	Stop recording and return to 0
4 CH	Playback temporary stop	Stop playback and the counter stops
STAMINA		
MTR	Recording	Stop recording and the counter stops
	Playback	Stop playback and the counter stops
	Recording temporary stop	Stop each movement
	Playback temporary stop	

[PLAY/PAUSE] button

STEREO	Stop	Start playback and the counter begins to move
4 CH	Recording standby	Starts recording
STAMINA	Recording, temporary stop	Restarts recording
MTR	Playback, temporary stop	Starts playback
MTR	Stop	Start playback
	Recording	While overwrite setting : Stops recording While always new setting : Pauses recording
	Recording standby	Start recording and the counter begins to move
	Playback	Pause playback

Operations

1-01 Setting / Recording: Set input source and recording level

Control settings for the targets, built-in microphones or external input jacks.

STEREO MODE

Use the stereo input source of either [MIC] or INPUT [1] [2].

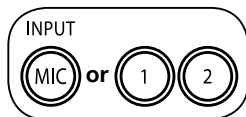
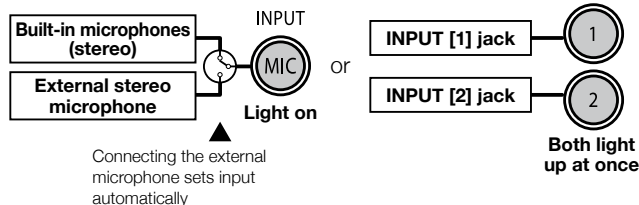

1 Select INPUT and press.

* Selection is available at any time during Stop, Recording Standby or Recording.

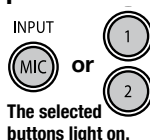

2 Press REC LEVEL and adjust the levels.

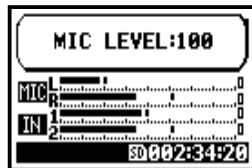
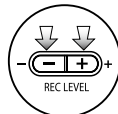

4CH MODE

Use both [MIC] and INPUT [1] [2] stereo input.

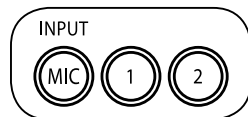
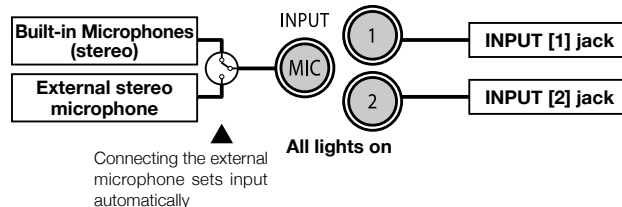

1 Select INPUT and press.

The recording level selected is displayed

2 Press REC LEVEL and adjust the levels.

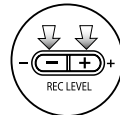

HINT:

On the top screen of the 4CH mode, press REC LEVEL button, and display "REC LEVEL TARGET" appears. Select the input and press.

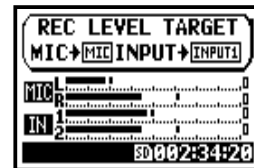

MTR MODE

Any of tracks 1-4 can be set for mono or stereo input.

SELECT the input per track one by one and adjust.

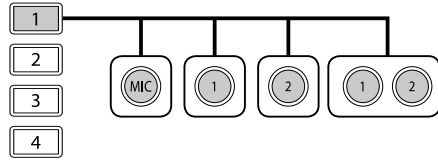

SELECT the input to 2 tracks and adjust.

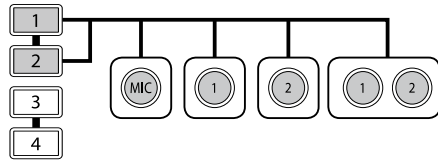

TRACK 1	TRACK 2	TRACK 3	TRACK 4
MONAURAL	STEREO	MONAURAL	MONAURAL
STEREO		MONAURAL	MONAURAL
MONAURAL	MONAURAL	STEREO	
STEREO		STEREO	

Use the REC LEVEL

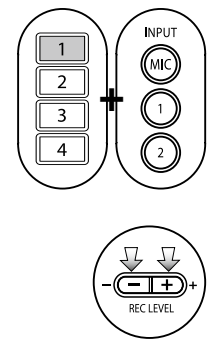

1 Press the selected track and input button.

2 Press REC LEVEL and adjust the level.

HINT:

In MTR mode, you can record multiple tracks in multiple passes. You can also send any input to any track.

1-02 Setting / Recording: Recording in STEREO and STAMINA mode

These are the steps to begin recording in STEREO or STAMINA mode.

[RECORDING DIRECTION]

Confirmation of the mode.
(Stereo mode)

* Change the FILE setting.
• REC FORMAT,
• FILE NAME TYPE

* Use the recording functions.
AUTO REC/STOP, PRE REC,
REC LEVEL AUTO

* Use METRONOME

1. Recording standby
2. Select the input source
3. Adjust the recording level of the source

Recording
4. Start recording: Temporary stop, Start recording again, Put a mark

5. Recording completes

*marks mean you can record without those settings.

STEREO **STAMINA**
Press the [MENU] button for more than 2 seconds, and start operation from the top screen.

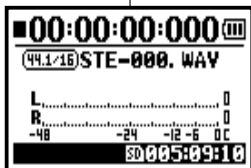

STEREO MODE TOP

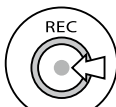

light blinks

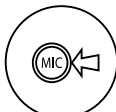

light on



1 [RECORDING STANDBY] press.



a new file name here

2 Select an input source and press.

Using built-in microphones, press [MIC], using external inputs press INPUT [1] and INPUT [2].

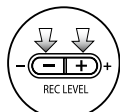

light on

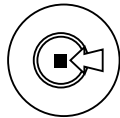

light off



3 Adjust the recording level of the input source.

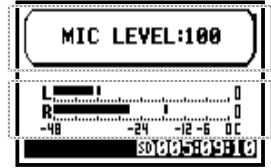

4 [REC START] press.

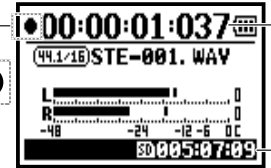

The number figures rotate.

5 [REC FINISH] press.

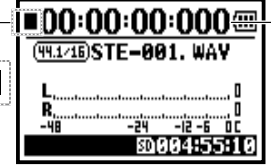

The counter returns back to 0.

[TEMPORARY STOP]



Counter doesn't return to 0.

[RECORDING AGAIN]



You can start recording from the position you stopped on the same file.

HINT:

<REC FORMAT>

In STEREO mode you can record in 19 different file formats using WAV and MP3. Recording format must be selected before recording of a file begins.

<FILE NAME> change MARK

Recorded files are named automatically. You can choose from two formats:

<DEFAULT> and <DATE>.

<DEFAULT> : STE-xxx

<DATE> : 090531-xxx

* The recording date is written.

The initial format is <DEFAULT>

When the recording format is WAV, you can mark your file by pressing the [REC] button while recording. You can move swiftly to the marked position during playback. When you make a temporary stop on WAV FILE, the mark will be placed at the stop position.

NOTE:

While recording and playback, no <REC FORMAT> change nor FILE NAME TYPE change is possible.

Ref.

<REC FORMAT>	P.051	<FILE NAME>	P.052
Mark setting	P.096	<METRONOME>	P.079
<AUTO REC>	P.065	<PRE REC>	P.067
<REC LEVEL AUTO>	P.070		

1-03 Setting / Recording: Recording format <REC FORMAT>



Choose recording file settings <REC FORMAT> before recording.

STEREO **4CH** Press the [MENU] button for more than 2 seconds, and start operation from the top screen.



1 Press.



2 Select <REC> and press.

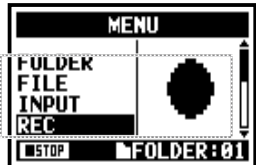

3 Select <REC FORMAT> and press.

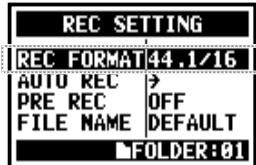

"Short cut"
Pressing TRACK [4] on the top screen.



4 Select one and press.



default;
WAV44.1 kHz/16bit.

NOTE:

How to use WAV and MP3 format

- The WAV FILES with no compression are used for high quality sound recording. Because data is not compressed, the volume of the file will increase compare to MP3 format.
- MP3 FILES decrease the sound quality because of data compression, but are useful to save SD card capacity and to record much more sounds.

HINT:

VARIETY OF WAV FILES

Formats are: 44.1/48/96 kHz indicates the sampling rate of the analog-to-digital conversion. 16/24-bit indicates the bit depth of the analog-to-digital conversion.

The larger the number, the higher the sound quality, but the files that are created are larger as well.

The WAV files recorded on STEREO/4CH/STAMINA mode correspond to BWF (Broadcast Wave Format) and include marks and production date.

VARIETY OF MP3

Select the bit rate which indicates information volume per minute. The bigger the number, the lower the rate of compression and the higher the sound quality. The higher compression MP3 will occupy less space on an SD card

VBR (Variable Bit Rate) means the bit rate (recording quality) is automatically adjusted based on input information.

REC FORMAT	
STEREO mode	
WAV	44.1kHz/16bit
	44.1kHz/24bit
	48kHz/16bit
	48kHz/24bit
	96kHz/16bit
MP3	96kHz/24bit
	48kbps
	56kbps
	64kbps
	80kbps
	96kbps
	112kbps
	128kbps
	160kbps
	192kbps
224kbps	
256kbps	
320kbps	
VBR	
4CH mode	
WAV	44.1kHz/16bit
	44.1kHz/24bit
	48kHz/16bit
	48kHz/24bit

1-04 Setting / Recording: File name <FILE NAME>



When recording, a file name is automatically assigned. To change that, take the following steps.

Press the [MENU] button for more than 2 seconds, and start operation from the top screen.

1

Press.

2

Select <REC> and press.

3

Select <FILE NAME> and press.

4

Select and press.

The initial notation is <DEFAULT>

File Name	
STEREO mode:	
<DEFAULT>	STE-xxx.wav (mp3) : 'STE-'3 figures, extension * <MONO MIX> setting MONO-xxx.wav(mp3) : 'MONO' 3 figures, extension
<DATE>	090531-xxx.wav(mp3) : year, date yymmdd-3 figures, extension
4CH mode:	
No change	4CH-xxxM.wav Record file of the built-in microphones: '4CH-' 3 figures 'M' extension 4CH-xxxI.wav Record file of the external input: '4CH-' 3 figures 'I' extension
MTR mode:	
STEREO FILE	TRK1-xx.wav : 'TRK' track number- 2 figures, extension
MONO FILE	* On stereo tracks put the track number like [1] [2] using L and R.

NOTE:

- You can set the DATE type only on STEREO mode.
- You can use other file names on STEREO and MTR mode. Those setting is operated on <FILE RENAME>

Ref.

<FILE RENAME>

P.109

1-05 Setting / Recording: Recording on 4CH mode

This is the method to record 4 channel stereo sounds coming from the built-in mic and the external input jack.

[RECORDING DIRECTION]

Change to 4CH mode

* Change the FILE setting.
• REC FORMAT

Use the recording functions:
AUTO REC/STOP
• PRE REC
• REC LEVEL AUTO

* Use the METRONOME

1. Recording standby.
2. Select the input source.
3. Adjust the recording level of the source.

Recording operation.
4. Start recording
• temporary stop
• record again
• put a mark on a file.

5. Recording completes.

*You can record skipping this step.

4CH Press the [MENU] button for more than 2 seconds, and start operation from the top screen.

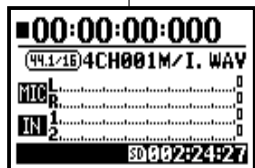

STEREO
MODE TOP



light blinks
REC

1 [RECORDING STANDBY] press.



blinks

a new file name here

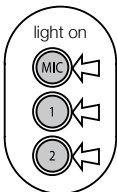

2 [Adjust the recording level] Select the input sources and press.

* When you use the built-in microphones: select [MIC]
Connection from outside: INPUT [1] and [2]

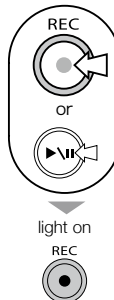
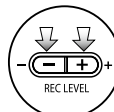

light on
REC

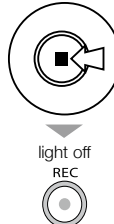

light off
REC

3 Adjust the recording level of the input sources.



4 [START RECORDING] press.

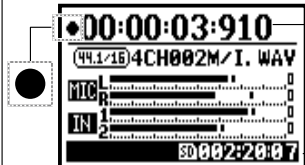

The number figures rotate.

5 [COMPLETE RECORDING] press.



Counter returns back to 0.

[TEMPORARY STOP]



light blinks



blinks

Counter doesn't return back to 0.

[RECORDING AGAIN]



light on



Continue recording from the position stopped on the same file.

HINT:

FILE NAME

On 4CH mode the input from the built-in and the external microphones is saved separately as STEREO WAV FILE.

Those 2 files are always administered as one pair and named as the following depending on the input:

[MIC] file: 4CHxxxM.wav

INPUT [1] [2] file: 4CHxxxI.wav

On screen 2 files noted 'M/I' at one time.

* You cannot change the file name.

<REC FORMAT> CHANGE

If you want change, operate before recording.

Mark

While the recording format is WAV, if you press [REC] button during recording operation, the mark is put on the file and you can move swiftly to the marked position during playback.

When you pause, that becomes the mark position.



file name

NOTE:

While recording and playback, no <REC FORMAT> is possible.

Ref.

<REC FORMAT>	P.051	<FILE NAME>	P.052
Mark setting	P.096	<METRONOME>	P.079
<AUTO REC>	P.065	<PRE REC>	P.067
<REC LEVEL AUTO>	P.070	Mode change	P.038

1-06-1 Setting / Recording: Recording in MTR mode

Using multiple tracks, you can combine mono and stereo recordings.

[RECORDING DIRECTION]

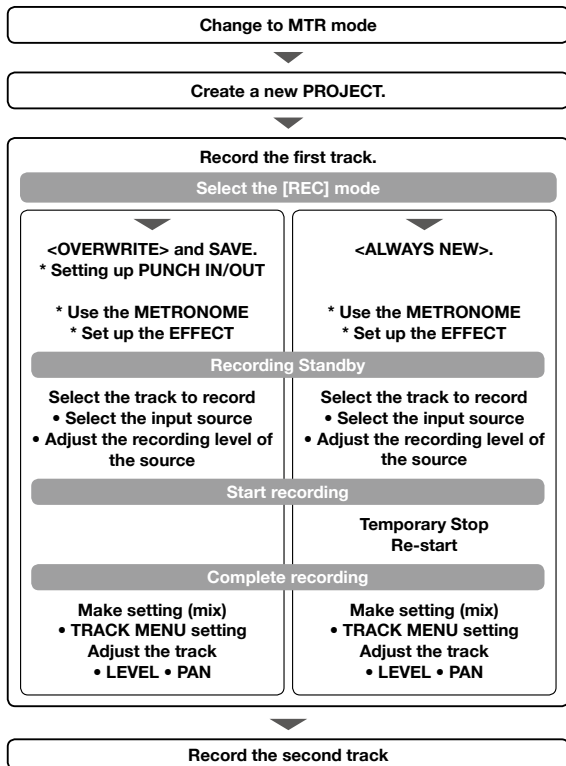

* This means you can record without this setting.

Change to <REC MODE>, <OVERWRITE/ ALWAYS NEW>



Press the [MENU] button for more than 2 seconds, and start operation from the top screen.

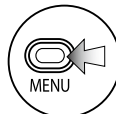

1 Press.



2 Select <REC MODE> and press.

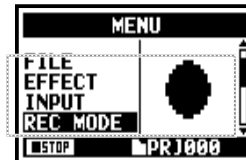

3 Select either <OVERWRITE> or <ALWAYS NEW> and press.



About INPUT SOURCE and TRACK

Only one recording track

1. Input source comes from either INPUT [1] or INPUT [2].



2. Input sources come from both [MIC]s or INPUT [1] & [2].

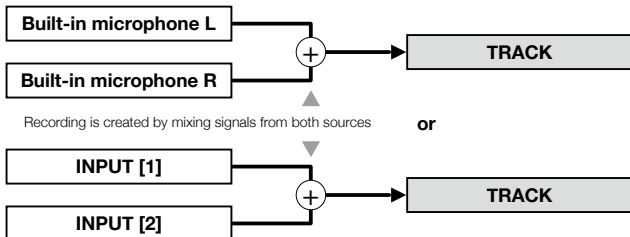

Two recording tracks

1. Input source comes from either INPUT [1] or INPUT [2].

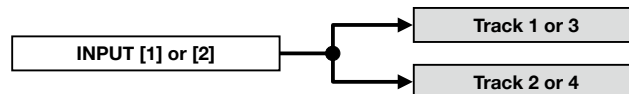

The same signals are sent to both tracks.

2. The input source comes from either [MIC] or INPUT [1] [2].

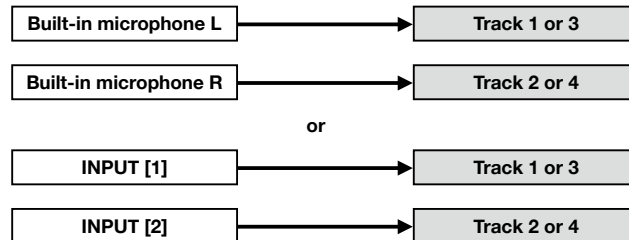

1-06-2 Setting / Recording: Recording <OVER WRITE> in MTR mode



You can select from two recording modes.

Using the <OVERWRITE> mode, you can overwrite new sounds on the existing file.



Press the [MENU] button for more than 2 seconds, and start operation from the top screen.

Choose the appropriate settings for your application
 Input setting ... P055
 Recording functions ... P059-

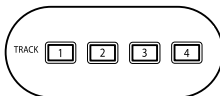

1 Select the TRACK.

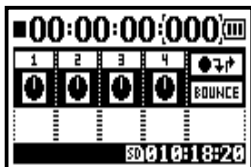

MTR MODE TOP

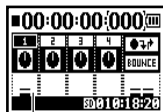

— displays input level

2 Press.

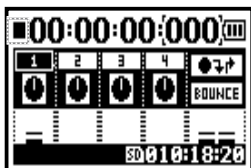

Counter won't be reset to 0 when using.

1

The selected 'TRACK' light on.

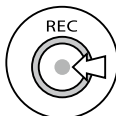

light on

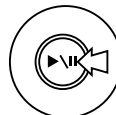

light on



3 [START RECORDING] press.

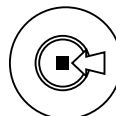
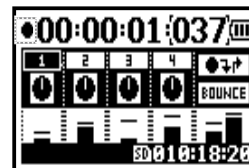

light off



4 [STOP RECORDING] press.

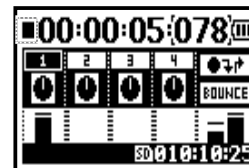

Counter doesn't return back to 0.

You can get back to the beginning of the file with the REW button. This will allow you to listen to what you've just recording by pressing the PLAY/PAUSE button.

1-06-3 Setting / Recording: Recording <ALWAYS NEW> in MTR mode



In ALWAYS NEW, a new file is made whenever it records.

MTR Press the [MENU] button for more than 2 seconds, and start operation from the top screen.

Choose the appropriate settings for your application
 ☞ Input setting ... P055
 ☞ Recording functions ... P059-

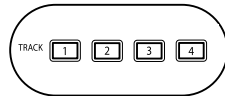

1 Select the TRACK.

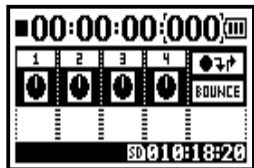

MTR MODE TOP

1
The selected TRACK light on.

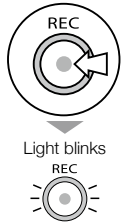

2 Press.

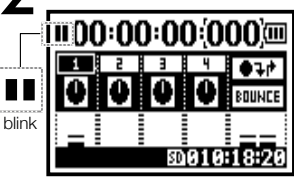

Counter won't be reset to 0 when using.

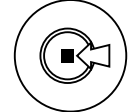
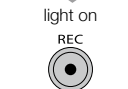
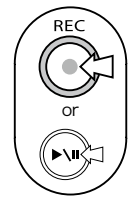

3 [START RECORDING] press.

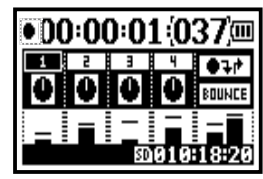

4 [STOP RECORDING] press.

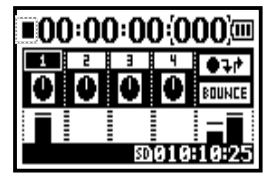

Counter return back to 0.

The PLAY/PAUSE button will allow you to listen back to the recorded file.

Setting / Recording: Recording <ALWAYS NEW> in MTR mode

1-07 Setting / Recording: TRACK MENU in MTR mode

This is an exclusive menu available only in MTR mode to set a track.

Link tracks together, create a stereo track, or you can create a special setting for output effects.



Press the [MENU] button for more than 2 seconds, and start operation from the top screen.

Select a target project and startP.119

Select TRACK MENU

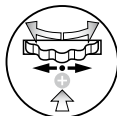

1 On the top screen select 'TRACK MENU ICON' and press.

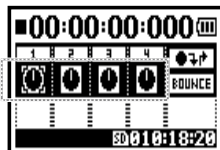

TRACK MENU icon

TRACK MENU file names allocated to tracks



currently selecting track

HINT LEVEL

Set the output level of a track
Setting value: Mute, -48.0dB _ +12.0dB
Default: 0.0dB

Adjust the output level of a track



Select <LEVEL> and press.



Set the value and press.

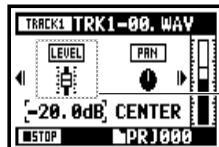
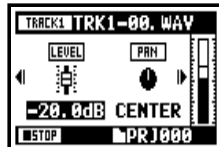

fader icon changes

HINT: PAN

Set the balance of Left and Right position of the tracks
Setting value: L100 _ C _ R100
Default: C (Center)

Adjust the output pan of a track



Select <PAN> and press.

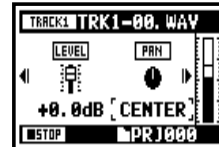

Set the value and press.

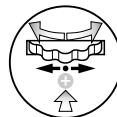

pan icon changes



NOTE:

Setting for <STEREO LINK>, <FILE> and <KARAOKE> are not available during recording, playback and also when tracks are armed.

HINT: STEREO LINK

Setting stereo link on creates a stereo track from tracks 1 and 2 or 3 and 4. Setting stereo link off creates a mono track. Setting value: ON/OFF Default: OFF

NOTE:

- You can only playback a mono file on 'MONO TRACK' and a stereo file on 'STEREO TRACK'.
- When <STEREO LINK> is turned on, no file will be assigned to the track, and "NO DATA" will be displayed.
- When you change from 'ON' to 'OFF', the setting of <PAN> returns to the previous one.
- When you change from 'OFF' to 'ON', the setting of <LEVEL> and <PAN> return to 'DEFAULT'.

NOTE:

- You cannot record on the <KARAOKE> track.
- When the <STEREO LINK> turns on automatically with a monaural track setting, it turns to "NO DATA" condition.
- When the <KARAOKE> track has been set, you cannot make the other tracks <KARAOKE>.

HINT:

You can only use KARAOKE setting on one pair of stereo tracks; either 1 and 2 or 3 and 4. In KARAOKE mode, you can set KEY CONTROL and CENTER CANCEL operations. Setting value: ON/OFF Default: OFF

Setting <STEREO LINK>

Allocate files to a track

Setting <KARAOKE>



Select <STEREO LINK> and press.

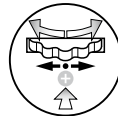

Select <FILE> and press.

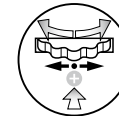

Select <KARAOKE> and press.



Set the value and press.

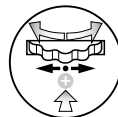

Select the <FILE> to be allocated and press.



Set the value and press.

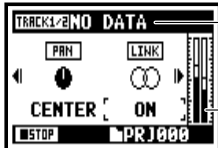

When change the format, the display says "NO DATA".

The display of 'LEVEL METER' changes 'STEREO'.

Display for the file list available to allocate with corresponding file style.



1-08-1 Setting / Recording: Re-recording, <PUNCH IN/OUT> automatic

This function, <PUNCH IN/OUT>, allows you to partially re-record a recorded file.
Here we explain how to start <PUNCH IN> and end <PUNCH OUT> automatically.



Press the [MENU] button for more than 2 seconds, and start operation from the top screen.

Change from <REC MODE> to <OVERWRITE>P.055

Allocate files to a track

Set the recording start position, <PUNCH IN>

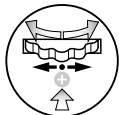

1 On the top screen select 'TRACK MENU ICON' and press.

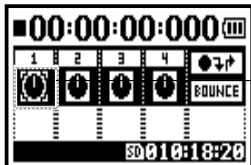

TRACK MENU icon

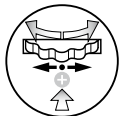

2 Select <FILE> and press.

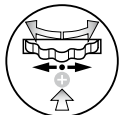

3 Select any desirable <FILE> and press.

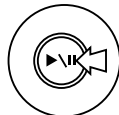

4 Press [START PLAYBACK].

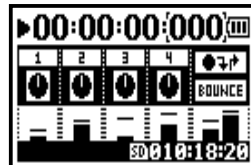

5 Select PUNCH IN / PUNCH OUT ICON and press.

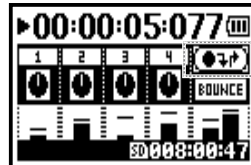

PUNCH IN / PUNCH OUT icon

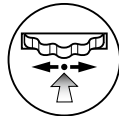

6 Find the desirable position for 'PUNCH IN' and press.

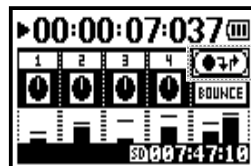

Icon interchanges

NOTE

Setting available on MTR mode and <OVERWRITE> recording.

Set the recording end position, <PUNCH OUT>



7 Press the desirable position for 'PUNCH OUT'.

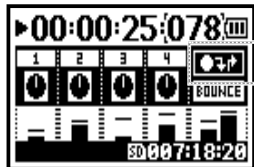

The PUNCH OUT setting confirmed

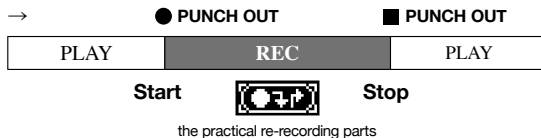

HINT:

- You can set the position for <PUNCH IN / OUT> while stopped by using the counter. First set each time and move the cursor to <PUNCH IN / OUT>, and then press [DIAL].
- During <PUNCH OUT> _ Step 7-, if you press [DIAL] again, all the setting will be cancelled.

Re-recording

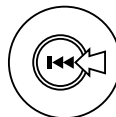

8 Rewind the file to the head (Counter: 0) or to the position to start re-recording 'PUNCH IN'.

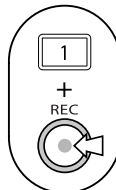

9 Press TRACK [1], Recording Standby.

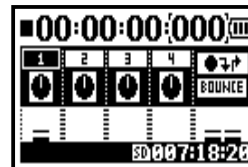

1

[1] When in punch in / out mode, the light is on during recording and blinks during record standby.

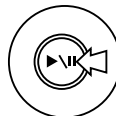

10 Press TRACK [1] [PLAYBACK _ RECORDING].

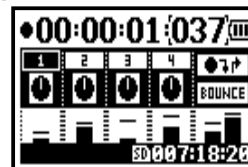

REC

When the track reaches the 'PUNCH IN' point, the REC light will turn on, recording will start.

1

[1] When the track reaches the 'PUNCH OUT' point, the light will blink and recording will stop.

Ref. Apportioning the time using a counter **P.102**

1-08-2 Setting / Recording: Re-recording, <PUNCH IN/OUT> manual

Using [OVERWRITE] recording operation in MTR mode, you can manually punch in and out. Press [REC] button during playback, from that pressed position you can start re-recording.



Press the [MENU] button for more than 2 seconds, and start operation from the top screen.

Change from <REC MODE> to <OVERWRITE>P.055

Allocate files to a track



1 On the top screen select 'TRACK MENU ICON' and press.

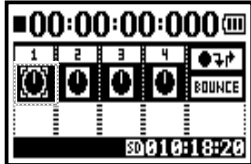

2 Select <FILE> and press.

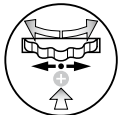
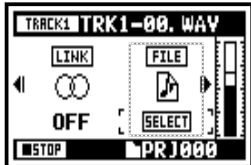

3 Select any desirable <FILE> and press.



Playback

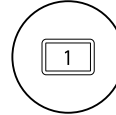

4 Press [RECORDING STANDBY].

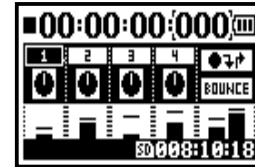

1 light on

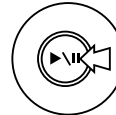

5 Press [START PLAYBACK].

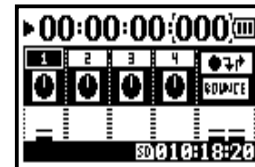

Setting / Recording: Re-recording, <PUNCH IN/OUT> manual

Re-recording (Manual <PUNCH IN/OUT>)



6 Performance (Not recording).

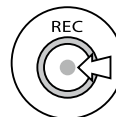

9 Press [FINISH RECORDING].

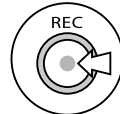
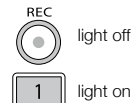
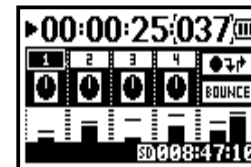

7 Press [START RECORDING].

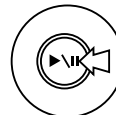
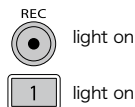
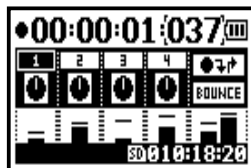

10 Press [PLAYBACK FINISH].

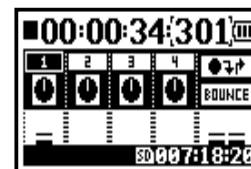

8 Performance (Recording).



Re-recording



2-01-1 Recording function <AUTO REC>



The H4n can detect when the input level surpasses your predetermined level, and can automatically start recording from the recording standby position.

Pressing the [MENU] button long for two seconds, start to operate from the top screen of the MODE.

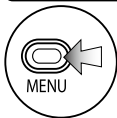

1 Press.



2 Select <REC> and press.

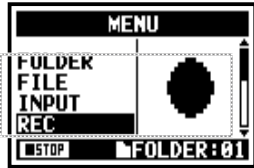

3 Select <AUTO REC> and press.

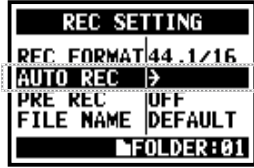

4 [START LEVEL SETTING] Select <START LVL> and press.

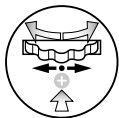

5 Adjust the level.



Set the input level to start recording automatically.



6 Select <ON/OFF> and press.



7 Select <ON> and press.

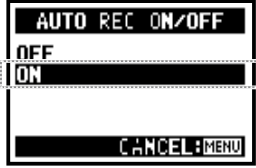

HINT:

Display of "Wait for Signal"

While <AUTO REC> operation is on, the display of "Wait for Signal" appears during recording standby. That watches whether the present input level goes over the recording start level.

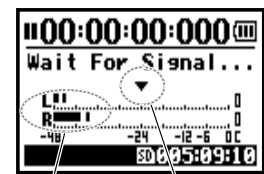

Present input level Start level

During "wait for signal" you can also start recording manually by pressing the REC button.

NOTE:

- You cannot use this setting during recording and playback.
- You cannot use this function together with <REC LEVEL AUTO>, <PRE REC> and <PRE COUNT>.

2-01-2 Recording function <AUTO REC STOP>



When <AUTO REC> is on and recording, the H4n will automatically stop recording when the input level goes below a predetermined level.

STEREO 4 CH Press the [MENU] button for more than 2 seconds, and start operation from the top screen.

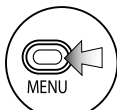

1 Press.



2 Select <REC> and press.

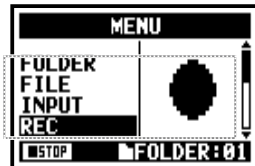

3 Select <AUTO REC> and press.

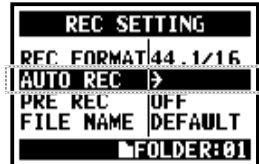

4 [STOP LEVEL SETTING] Select <STOP LVL> and Press.



5 Adjust the level.

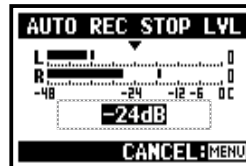

Set the input level at which recording will stop



6 Select <AUTO STOP> and press.



7 Select the time setting.



Select from 1-5 seconds to stop recording after the signals have become lower than the STOP LEVEL.

HINT:

When <[AUTO REC STOP]> is on, 'STOP LEVEL' display appears during recording.



Stop level

Present input level



NOTE:

- You cannot use this function during recording and playback.
- When <AUTO REC STOP> is on, you can finish recording with pressing [STOP] button.

2-02 Recording function <PRE REC>



The <PRE REC> setting can be initialized by pressing the [REC] button, automatically adding the previous 2 seconds to your recording.

  Press the [MENU] button for more than 2 seconds, and start operation from the top screen.

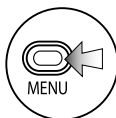

1 Press.

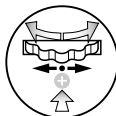

2 Select <REC> and press.

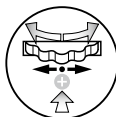
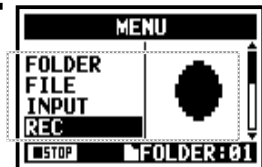

3 Select <PRE REC> and press.

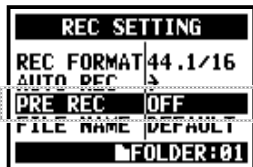

4 Select <ON> and press.

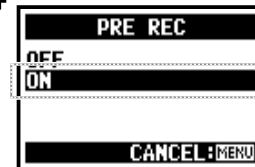

HINT

In PRE REC mode the H4n will pre-record audio two seconds before the record button is pressed.



NOTE

- You cannot use this setting during recording and playback.
- When recording on 96 kHz, 4CH mode, the maximum PRE REC time is one second.
- You cannot use this function together with AUTO REC and PRE COUNT.

2-03 Recording function <LO CUT>



The <LO CUT> filter setting allows you to eliminate wind or blowing noises.

   Press the [MENU] button for more than 2 seconds, and start operation from the top screen.

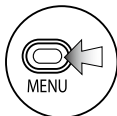

1 Press.

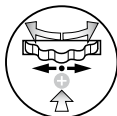

2 Select <INPUT> and press.

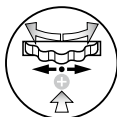
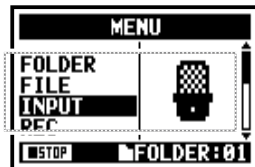

3 Select <LO CUT> and Press.

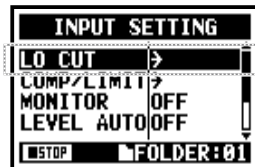

4 Select the setting input source.

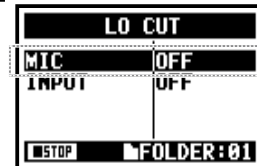

5 Select the cutoff frequency.



HINT:

- You can Select the <LO CUT> filter among eleven frequencies, such as OFF, 80, 98, 115, 133, 150, 168, 185, 203, 220, and 237 Hz. When selecting higher numbers, you should verify the outcome before recording.
- The smaller the number, the lower the cut-off frequency.

2-04 Recording function <COMP/LIMIT>



The <COMP / LIMIT> setting can compensate for volume differences. For each input source, low level input signals are lifted up and high level input signals are controlled down when recording.

STEREO **4CH** Press the [MENU] button for more than 2 seconds, and start operation from the top screen.

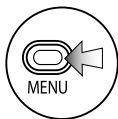

1 Press.

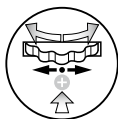

2 Select <INPUT> and press.

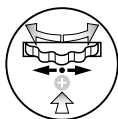
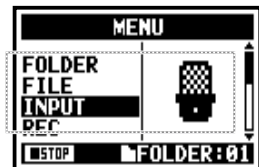

3 Select <COMP/LIMIT> and press.

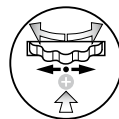
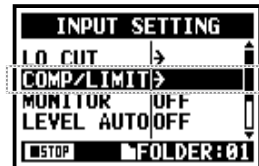

4 Select the setting input source.

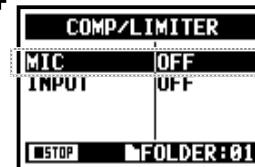

5 Select the setting target.



HINT:

OFF	Compressor and Limiter are off	
COMP1 (GENERAL)	Standard compressor	The compressor can compress higher level sounds and raise the level.
COMP2 (VOCAL)	Compressor suitable for vocal	
COMP3 (DRUM)	Compressor suitable for drum and percussion	
LIMIT1 (GENERAL)	Standard limiter	The limiter can compress when the input signals go over the fixed level
LIMIT2 (CONCERT)	Limiter suitable for 'live'	
LIMIT3 (STUDIO)	Limiter suitable for 'studio' recording	

2-05 Recording function <REC LEVEL AUTO>



This function automatically sets the level for recording.

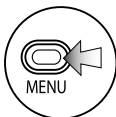
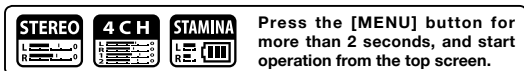

1 Press.



2 Select <INPUT> and press.

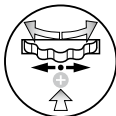
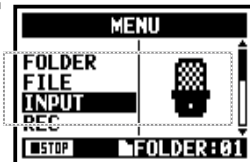

3 Select <LEVEL AUTO> and press.

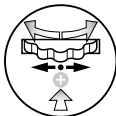
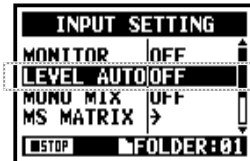

4 Select <ON>



HINT:

When <REC LEVEL AUTO> is used, the unit automatically determines the recording levels using the signal present during recording standby. If the volume surpasses 6dB during recording, the input level is automatically adjusted with the new level displayed on the screen for two seconds.

Display when recording standby Present input level

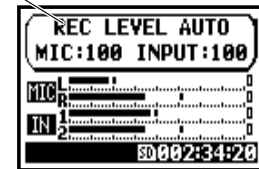

STEREO MODE

4CH MODE

Display when -6dB is exceeded while recording

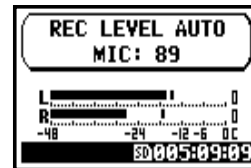

NOTE:

- You cannot use this function together with <AUTO REC>.
- You cannot use this setting during recording and playback.

2-06 Recording function <MONITOR>



Turning on the MONITOR function allows you to monitor input signals at all times.

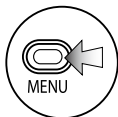

1 Press.

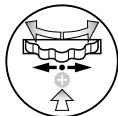

2 Select <INPUT> and press.

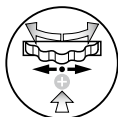
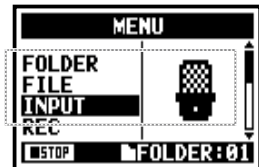

3 Select <MONITOR> and press.

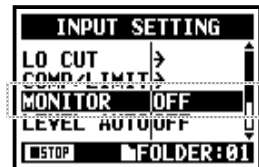

4 Select <ON> and press.

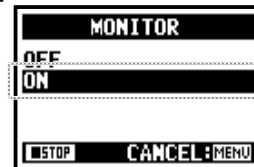

HINT:

You can always monitor the input source through [LINE/PHONE MINI STEREO OUT] during recording standby.



NOTE:

You cannot monitor the input sound through the built-in speaker.

2-07 Recording function <MONO MIX>



Engaging <MONO MIX> blends the left and right signals down to mono then records dual-mono to each left and right channel.

  Press the [MENU] button for more than 2 seconds, and start operation from the top screen.

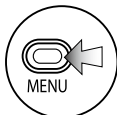

1 Press.

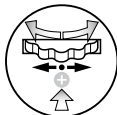

2 Select <INPUT> and press.

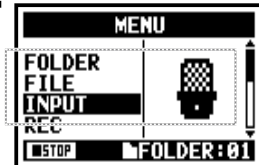

3 Select <MONO MIX> and press.



4 Select <ON> and press.



NOTE:

- The name of the recorded file making <MONO MIX> valid is “MONO-xxx”
- You cannot use this function together with <MS STEREO MATRIX>.
- You cannot use this setting during recording and playback.

2-08 Recording function <MS STEREO MATRIX>

This function enables you to convert the stereo microphone signals when using a MID/SIDE recording configuration.

STEREO 4 CH Press the [MENU] button for more than 2 seconds, and start operation from the top screen.

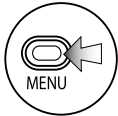

1 Press.



2 Select <INPUT> and press.

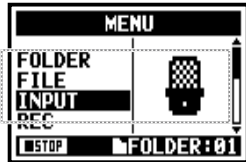

3 Select <MS MATRIX> and press.



4 Make each setting accordingly.



<ON / OFF>

Make the setting <ON/OFF> of <MS STEREO MATRIX>.



Select



Select

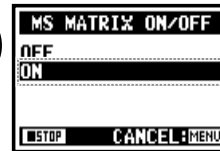

<MID LEVEL>

<MID> is a directional microphone receiving the recording targets.

Setting value: MUTE, -48.0 _ +12.0dB
Default: +0.0dB



Select



Adjust



Recording function <MS STEREO MATRIX>

<SIDE LEVEL>

A bi-directional microphone <SIDE> and <MID> are perpendicular each other.
 Setting value: MUTE, -48.0_ +12.0dB
 Default: +0.0dB

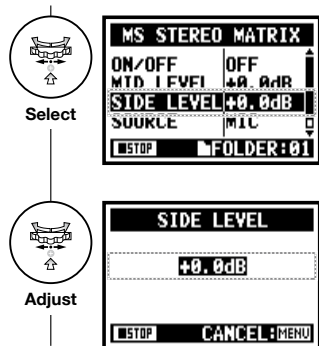

<SOURCE>

Enable to select what input is effective.
 (Only on 4CH mode)

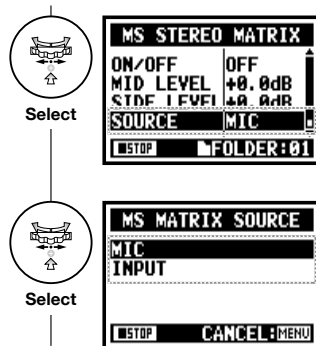

<CH SETTING>

Allocate <MID> inputs and <SIDE> inputs between L-ch (INPUT [1]) and R-ch (INPUT [2]).

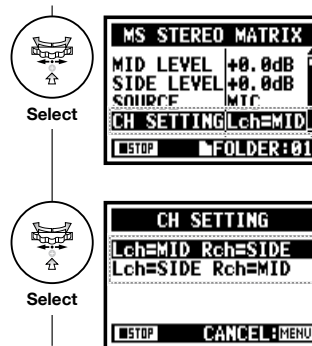

NOTE:

You cannot use this function together with <MONO MIX>.

3-01-1 Tuner <TUNER (CHROMATIC) >



The H4n features a tuner with multiple tuning modes.

STEREO **4 CH** **MTR** Press the [MENU] button for more than 2 seconds, and start operation from the top screen.

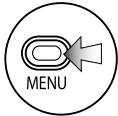

1 Press.



2 Select <TOOL> and press.

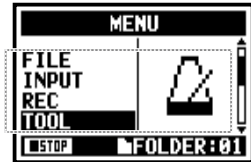

3 Select <TUNER> and press.

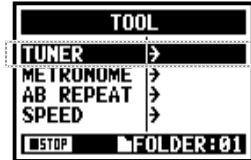

4 Select <CHROMATIC> and press.

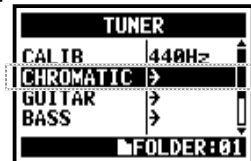

5 Tuning.

The indicator shows the input signals are higher or lower than the 'NOTE' described below.

Both marks light on when the inputs signals match the 'NOTE'.

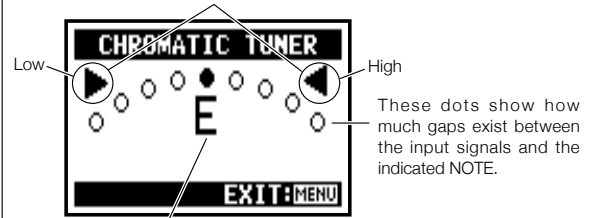

The name of the [NOTE] shows the nearest one to the input signals.

HINT:

- The input source signals selected at the present become the tuning target.
- Operating under 4CH mode, at Step 4 select <INPUT> and select the input source, and then continue to steps 5.

NOTE:

Not available during recording and playback.

Ref. Display of tuning
Relationship between string numbers and notes **P.078**

3-01-2 Tuner, all other <TUNER>



Aside from CHROMATIC, there are other tuning modes such as GUITAR, BASS, OPEN A, OPEN D, OPEN E, OPEN G and DADGAD.

STEREO **4 CH** **MTR** Press the [MENU] button for more than 2 seconds, and start operation from the top screen.

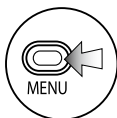

1 Press.



2 Select <TOOL> and press.

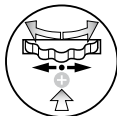
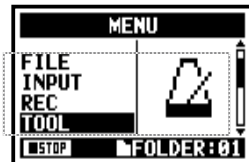

3 Select <TUNER> and press.

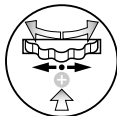
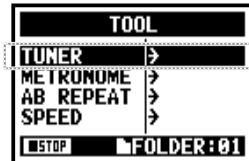

4 Select the tuning mode and press.

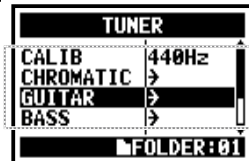

5 Tuning.

The indicator shows the input signals are higher or lower than the 'NOTE' described below. Both marks light on when the input signals match the 'NOTE'.

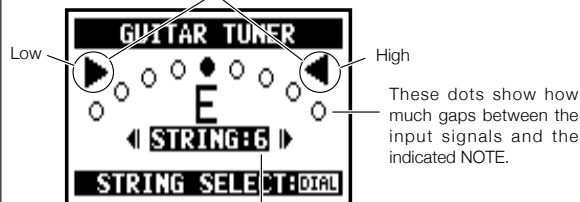

String number currently selected.
You can [DIAL] and select.

HINT:

- The input source signals selected at the present become the tuning target.
- Operating under 4CH mode, at Step 4 select <INPUT> and select the input source, and then continue to steps 5.

NOTE:

Not available during recording and playback.

Ref. Display of tuning
Relationship between string numbers and notes **P.078**

3-01-3 Tuner <TUNER (CALIB)>



This function allows you to calibrate the tuner.

Press the [MENU] button for more than 2 seconds, and start operation from the top screen.

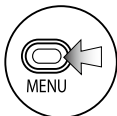

1 Press.

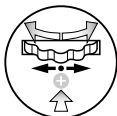

2 Select <TOOL> and press.

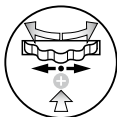
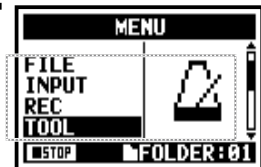

3 Select <TUNER> and press.

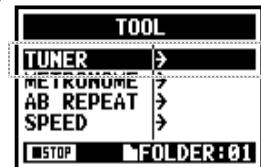

▶ The <TUNER> operation up to here is in common.



4 Select <CALIB> press.

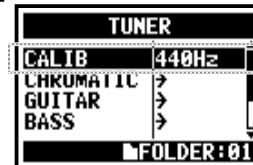

5 Select frequency numbers.

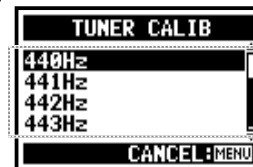

HINT:

- The initial setting is 440Hz.
- You can make any setting per 1Hz from 435Hz to 445Hz.

NOTE:

Not available during recording and playback.

3-01-4 Tuner <TUNER (INPUT) >

In 4CH mode you can select the input source for the tuner.

 Press the [MENU] button for more than 2 seconds, and start operation from the top screen.

<TUNER>...P.075

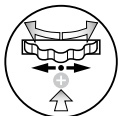

4 Select <INPUT> and press.

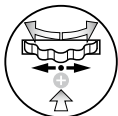
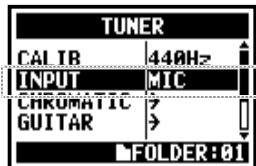

5 Select input source and press.

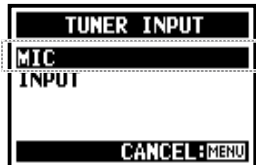

HINT:   

Tuning display

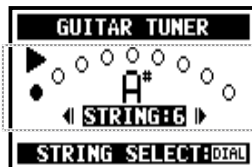

When tuning is low

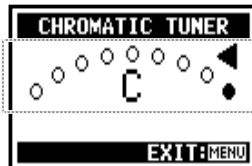

When tuning is high

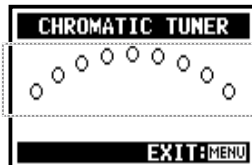

No input sound (chromatic)

Tuner type and code

Tuner type	String number/ note name						
	1	2	3	4	5	6	7
GUITAR	E	B	G	D	A	E	B
BASS	G	D	A	E	B		
OPEN A	E	C#	A	E	A	E	
OPEN D	D	A	F#	D	A	D	
OPEN E	E	B	G#	E	B	E	
OPEN G	D	B	G	D	G	D	
DADGAD	D	A	G	D	A	D	

NOTE:

Not available during recording and playback.

3-02 Metronome <METRONOME>

The metronome has other convenient functions such as click, pre-count, tempo, sound, etc.

STEREO **4 CH** **MTR** Press the [MENU] button for more than 2 seconds, and start operation from the top screen.

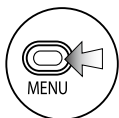

1 Press.

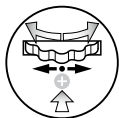

2 Select <TOOL> and press.

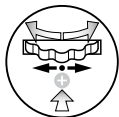
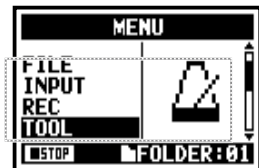

3 Select <METRONOME> and press.

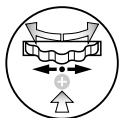
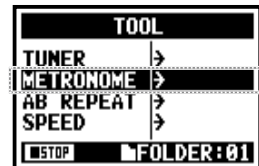

4 Make each setting selection.

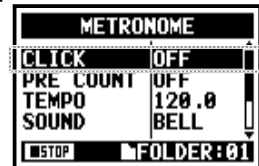

<CLICK>

This setting turns the metronome on or off during recording, playback or both. This setting must be made before recording or playback.



Select

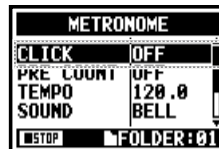

Select

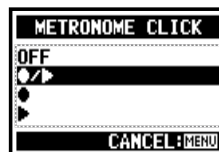

Select conditions

- OFF
- / ● --Recording / Playback
- ---Only during recording
- ▶ ---Only during playback

<PRE COUNT>

Set the count number just before the beginning of recording. Setting is impossible when <PRE REC> and <AUTO REC> is ON.



Select

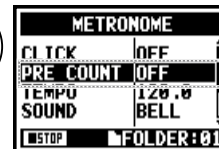

Select

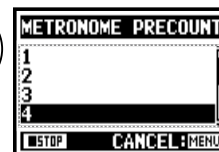

Select beat.

Select among OFF, 1-8 beat and SPECIAL.

Count of <SPECIAL>

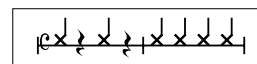

NOTE:

The metronome starts at the beginning of recording and playback. If you start in the middle of a song or track, the metronome beats may not be in sync with the song.

<TEMPO>

Set the metronome speed.

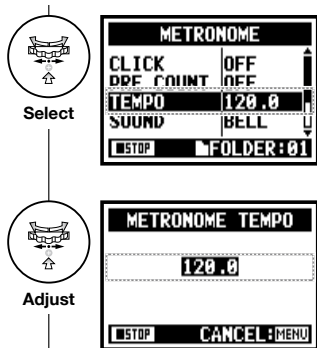

default: 120.0.

You can set between 40.0 and 250.0 BPM, per 0.1.

<SOUND>

Set the metronome tone.

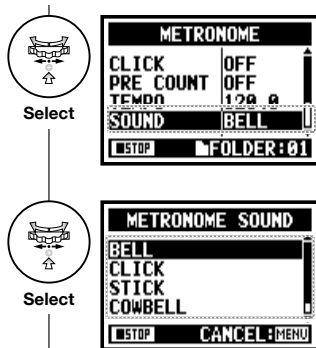

default: bell sound.

You can select among BELL, CLICK, STICK, COWBELL and HI-Q.

<PATTERN>

Set the pattern of the metronome.

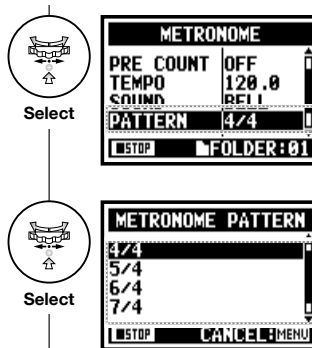

default: 4/4.

You can select among 0/4 (no accent), 1/4_ 8/4, and 6/8.

<LEVEL>

Set for the volume of the metronome.

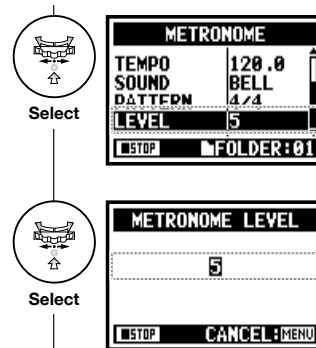

You can select among eleven levels.

3-03-1 All about EFFECT

Brief outline about how to use <EFFECT>, its flow, input and output

[Flow of the EFFECT]

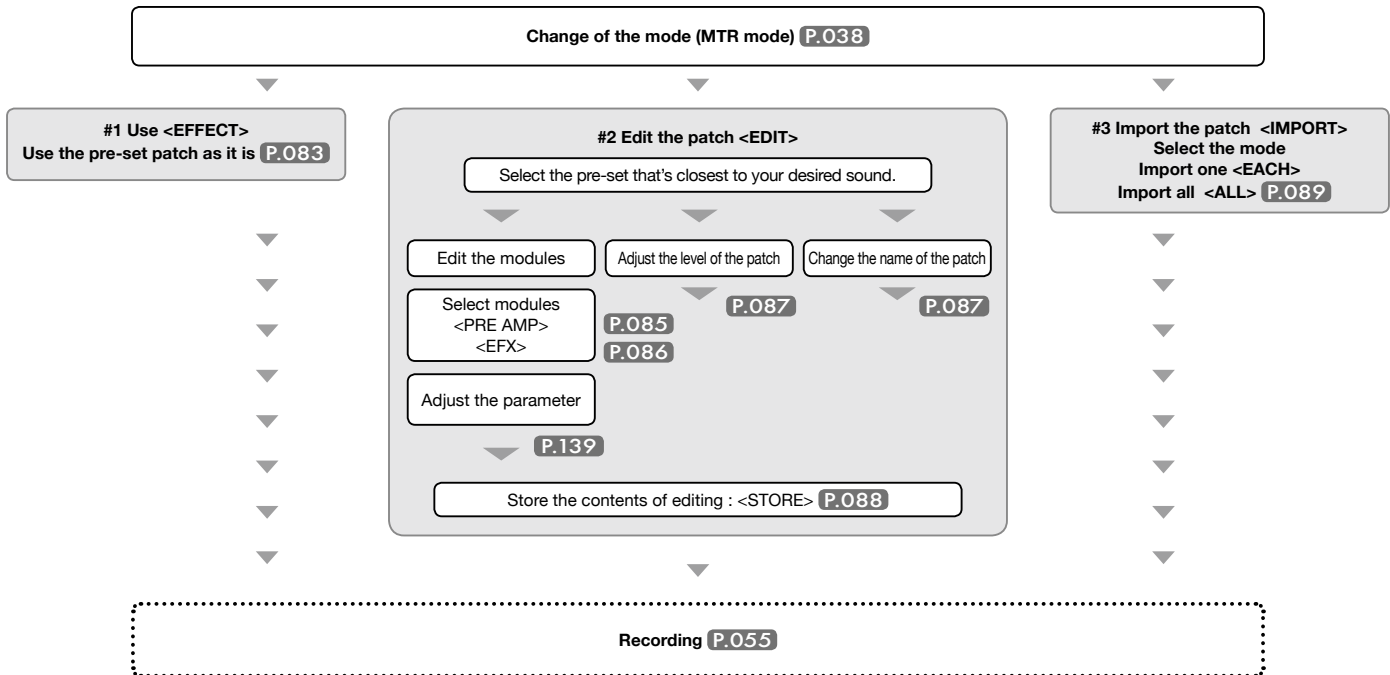

About input and output of [EFFECT]

You can use EFFECT in MTR mode for mono or stereo signals. The flow of signals will change corresponding to the input sources and recording tracks.

One recording track:

1. Input source comes from either INPUT [1] or [2]



2. Input source comes from either [MIC] or INPUT [1] [2]

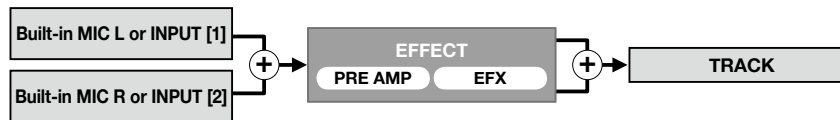

Two recording tracks:

1. Input source comes from either INPUT [1] or [2]

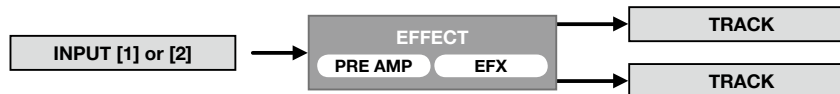

2. Input source comes from either [MIC] or INPUT [1] [2]

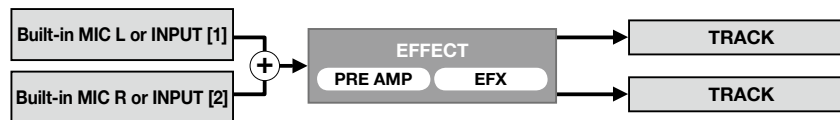

3-03-2 Effect <EFFECT>

Using the EFFECT made up of 2 modules in MTR mode, you can add various effects to the input signals.

Effect <EFFECT>

 Press the [MENU] button for more than 2 seconds, and start operation from the top screen.

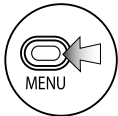

1 Press.



2 Press <EFFECT> and press.

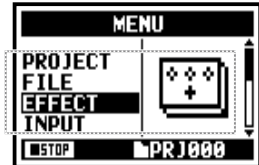

3 Press <ON> and press.

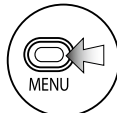

4 Select No. : PATCH NAME and press.

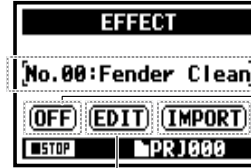

PATCH NUMBER: PATCH NAME.

When EFFECT is on, display will show off.

IMPORT: Carry in a PATCH from the other PROJECT

EDIT: Create a new PATCH, Edit a PATCH.

5 Select PATCH and press.

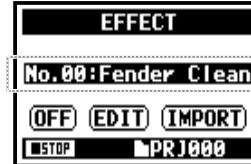

Ref.  patch list

P.145

P.146

6 Pressing [MENU] for more than two seconds returns you to the top screen.

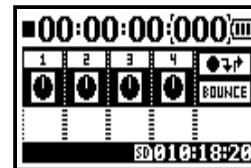

NOTE:

PATCH

Effects module settings are saved as a 'patch'.

60 patches are available and 50 of them have been programmed.

3-03-3 Effect <EDIT>, patch edit

You can create your own patch by combining effects and adjusting the parameter settings.

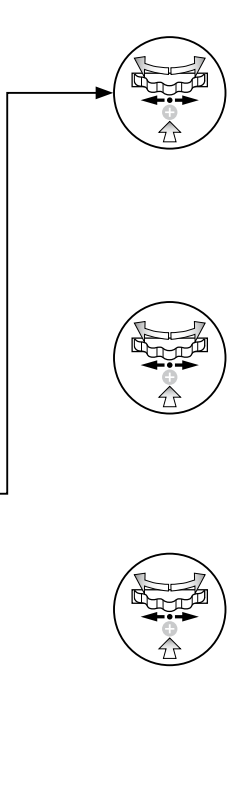

5 Select the desired sound No. :PATCH NAME and press.

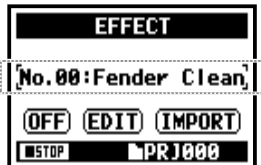

6 Select <EDIT> and press.



7 Select the PARAMETER which you want to change and press.

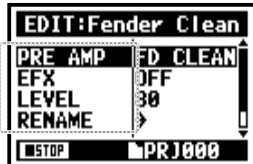

EDIT MENU

<PRE AMP>
PRE AMP module contains guitar and bass amp modeling effects.



<EFX>
EFX module contains modulation, chorus and delay effects.

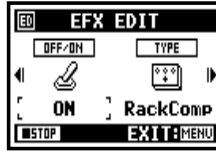

<LEVEL>
Adjust PATCH level.



<RENAME>
Change the PATCH NAME.



<STORE>
Save the set the PATCH.



3-03-4 Effect <EDIT (PRE AMP) >, editing PRE AMP modules

You can edit the PATCH using PRE SET EFFECT.

Select the desired PATCH and edit it...P084

ADJUST PRE AMP module



7 Select <PRE AMP> and press.

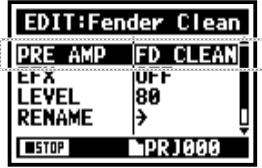

8 Press <ON/OFF> and PRE AMP module turns on.

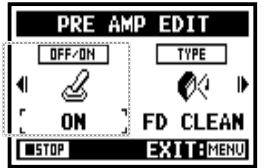

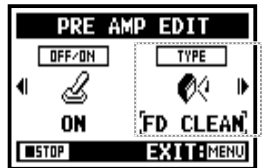

9 Select editing PARAMETER and press.

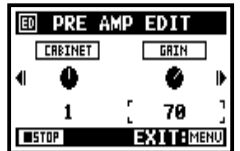
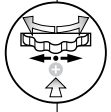
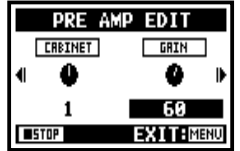
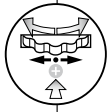
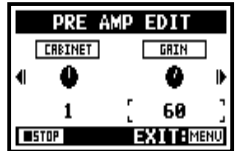
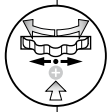

ADJUST PARAMETER



ICON

PRE AMP MODULE CONDITION
ON / OFF



EFFECT TYPE: SET THE AMP TYPE



CABINET.EQ.LEVEL. ETC.



ZNR ICON

Ref.  PRE AMP module PARAMETER **P.139**

Effect <EDIT (PRE AMP) >, editing PRE AMP modules

3-03-5 Effect <EDIT (EFX) >, editing EFX modules

Edit the patch by selecting from various parameters that correspond closest to your desired effect.

Select the nearest image PATCH and edit it...P084

ADJUST EFX module



7 Select <EFX> and press.

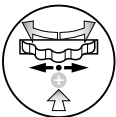

8 Press <ON/OFF> and EFX module turns on.

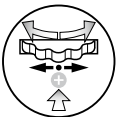

9 Select editing PARAMETER and press.

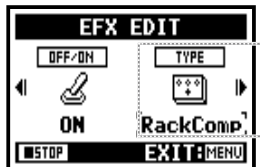



HINT:

To select PRE AMP and EFX modules, make setting after changing the module status ON.

Default: When a module is OFF, no parameters or settings are shown.

When OFF, you cannot select modules.

ICON

PRE AMP MODULE CONDITION
ON / OFF



EFFECT TYPE: SET THE EFX



VARIOUS PARAMETERS

Ref.  EFX module PARAMETER
P.141

Effect <EDIT (EFX) >, editing EFX modules

3-03-6 Effect <EDIT (LEVEL/RENAME) >

Adjust the levels of the patch and change the name.

EFFECT<EDIT>...P.084

LEVEL



1 Select <LEVEL> and press.

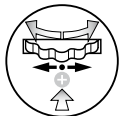

2 Change the number and press.



1 Select <RENAME> and press.

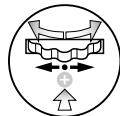
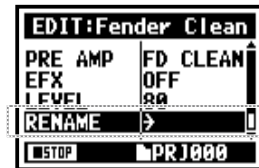

2 Change the PATCH name and press.

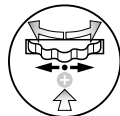
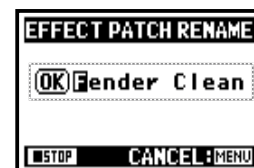

3 Select <OK> and press.



NOTE:

Select <STORE> to save the patch. To return to the top without saving the edit/change, hit MENU.

3-03-7 Effect <EDIT (STORE) >

EFFECT<EDIT>...P.084

STORE

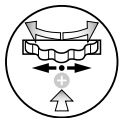

10 Select <STORE> and press.

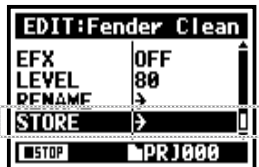

11 Select the 'PATCH No.' where to save and press.



12 Select <EXECUTE> and press.

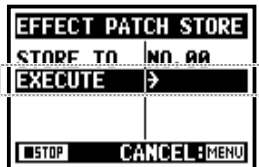

NOTE:

The items you edited have 'ED' display and confirmed by <STORE>operation.

Select not <STORE>.
(not stored)

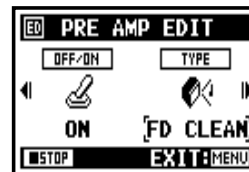

Confirmed <STORE>.

Selecting "YES" will overwrite the current patch. To save without overwriting an existing patch, select an empty patch during STORE operation. Patch changes are only stored for the current project.

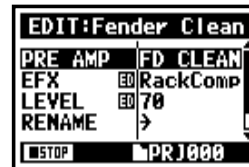

3-03-8 Effect <IMPORT>, taking in a patch from another PROJECT

You can apply the edited and saved EFFECT PATCH, used in other project to the current PROJECT.

Effect <IMPORT>, taking in a patch from another PROJECT

SELECTED EFFECT...P.083<EFFECT>
<ALL> read in all patches

1 Press <IMPORT> from the <EFFECT> screen.



EFFECT		
No.00:Fender Clean		
OFF	EDIT	IMPORT
[STOP] PRJ000		

2 Select <MODE> and press.



EFFECT PATCH IMPORT	
MODE	EACH
PROJECT	NO.001
NEXT	→
PRJ000	

3 Select your desired mode and press.



PATCH IMPORT MODE	
EACH PATCH	ALL PATCHES
PRJ000	

4 Select PROJECT and press.



PROJECT SELECT	
NO.000	PRJ000
NO.001	09-04-01
CANCEL:MENU	

5 Select <NEXT> and press.



EFFECT PATCH IMPORT	
MODE	ALL
PROJECT	NO.001
NEXT	→
PRJ000	

6 Select <YES> and press.



EFFECT PATCH IMPORT	
Are You Sure?	
YES	NO
CANCEL:MENU	

▼



EFFECT		
No.00:Fender Clean		
OFF	EDIT	IMPORT
[STOP] PRJ000		

All the patch selected at step 4 are now read in to the present project.

<EACH> import one patch

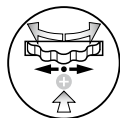

5 Select <NEXT> and press.

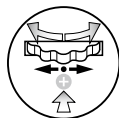

8 Select <YES> and press.

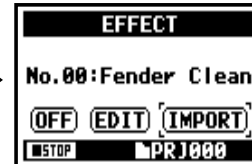
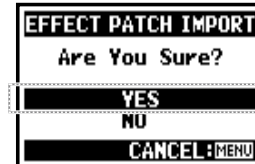

The patch selected at step6 is now imported to the present project.



6 Select an import patch and press.

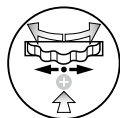
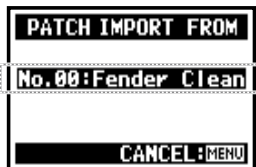

7 Select which patch you want to import to the present project and press.

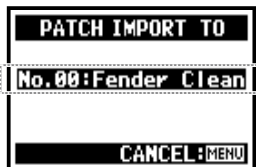

NOTE:

When pressing the <IMPORT>, "No Other Project!" display will appear when there is no PROJECT.

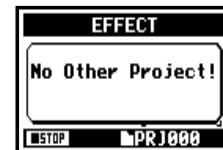

HINT:

- Read in MODE ▶
- Read in PROJECT ▶
- Start importing current PROJECT ▶



Selected PROJECT

3-04-1 A sing-along machine <KARAOKE> preparation

Create spontaneous music files and convert them into KARAOKE form, then record vocals or additional guitar sounds over those files.

[Flow of the KARAOKE]

[Preparation]

Prepare the stereo files for the background

Create a new project for "Karaoke"P.118

Import the file to the project

- Copy the file to the project folderP.039
- Use <MOVE> function.....P.117

[Setting KARAOKE]

(Prepare tracks for the Karaoke)

1. Select 'TRACK MENU ICON' and open the 'TRACK MENU'
2. Make <KARAOKE> on.
3. Allocate files.

[Adjustment of the Karaoke tracks]

- LEVEL
- CENTER CANCEL
- KEY
- FINE-FINE

[KARAOKE OPERATION]

4. Connect the microphone
5. Make the setting for the recording tracks
 - Playback
 - Recording
6. Make 'RECORDING' on.



Press the [MENU] button for more than 2 seconds, and start operation from the top screen.

KARAOKE track preparation

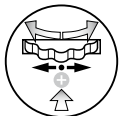

1 Select TRACK MENU icon and press.

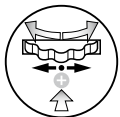
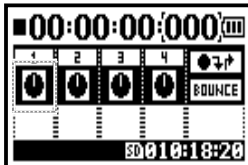

2 Select <KARAOKE> and press.

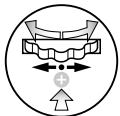

3 Select <ON> and press.



Allocate an optional file on to KARAOKE track

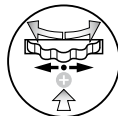

4 Select TRACK MENU icon and press.



5 Select <FILE> and press.

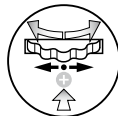
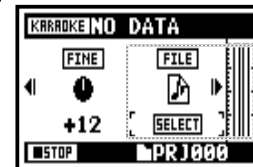

6 Select an optional file and press.



Continue to the next page 

Make CENTER CANCELATION of the KARAOKE track

Change the KEY of KARAOKE track



7 Select TRACK MENU icon and press.



8 Select <CNT CANCEL> and press.



9 Convert that into <ON> and press.



10 Select TRACK MENU icon and press.



11 Select <KEY> and press.



12 Adjust and press.

HINT:

The contents of KARAOKE TRACK are different from a general TRACK MENU.

(LEVEL)
 (CNT CANCEL)
 (KEY)
 (FINE)
 (FILE)
 (KARAOKE)

3-04-2 A sing-along machine <KARAOKE> recording

A slight adjustment of KARAOKE TRACK KEY.



13 Select TRACK MENU icon and press.

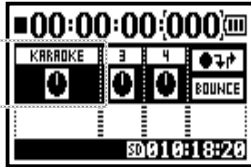

14 Select <FINE> and press.

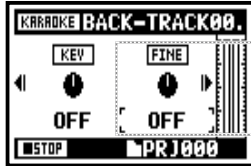

15 Make adjustment and press.



Recording on KARAOKE

1 Connect the microphone.

Press the INPUT button corresponding to the connected input jack.

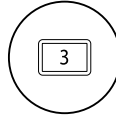

2 Select the track menu icon and press.

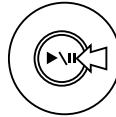
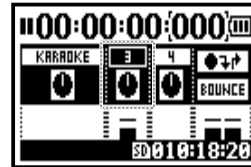

3 Press 'PRACTICE' (no recording).

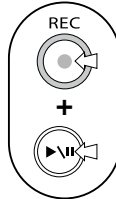

4 [START RECORDING]
Press [REC] button and make recording standby condition. After that press [PLAY/PAUSE] button to start recording.

NOTE:

You cannot use this function together with <EFFECT>.

Ref. 

<TRACK MENU> P.059

4-01 Playback : Playback files (stereo, 4ch and stamina modes)



Immediately after recording, you can playback the file by pressing the [PLAY/PAUSE] button.
If you prefer to call up the files for later playback, take the following steps.

STEREO **4 CH** **STAMINA** Press the [MENU] button for more than 2 seconds, and start operation from the top screen.

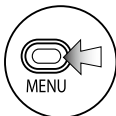

1 Press.

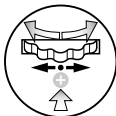

2 Select <FILE> and press.

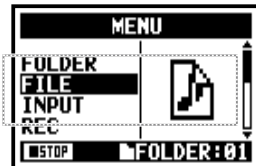

"Short cut"

Pressing TRACK [2] on the top screen.

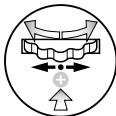

3 Select the targeted file and press.



4 Select <SELECT> and press.

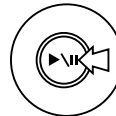

5 [START PLAYBACK] Press.

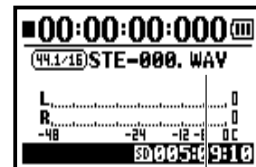

"Short cut"

You can select the file in the folders on the top screen.



You should confirm the file name.

HINT:

- On the top screen you can move directly to Step 3, just press TRACK [2] button.
- If you press [PLAY/PAUSE] button after selecting files, the selected file starts playback immediately.
- You can select files in the folder directly using [DIAL] from the top screen.

Ref.

<FILE SELECT> P.104

4-02 Playback : <PLAY MODE>



Aside from general playback, you can also select

1) one file only playback, 2) repeat playback of one file, and 3) all files repeat playback.

Playback : <PLAY MODE>

STEREO 4 CH STAMINA Press the [MENU] button for more than 2 seconds, and start operation from the top screen.

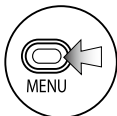

1 Press.



2 Select <PLAY MODE> and press.

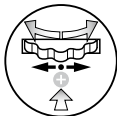
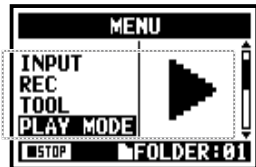

3 Select a play mode and press.



Select desirable mode.

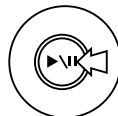

4 [START PLAYBACK] Press.

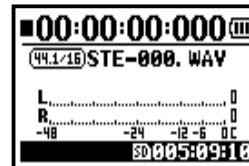

PLAY ALL	Playback all the files in the folder.
PLAY ONE	Playback one file.
REPEAT ONE	Playback repeat of one composition only.
REPEAT ALL	Playback all files in the folder.

NOTE:

You cannot use this setting during recording and playback.

4-03 Playback : Setting marks



While operating file playback you can create marks at desired spots.
You can move easily to the spot during playback.

How to create marks

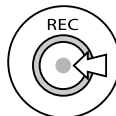

During playback operation, press the [REC] button.

How to playback the marked file

You can move to the marked position pressing [FF] and [REW] buttons in the files with marks.

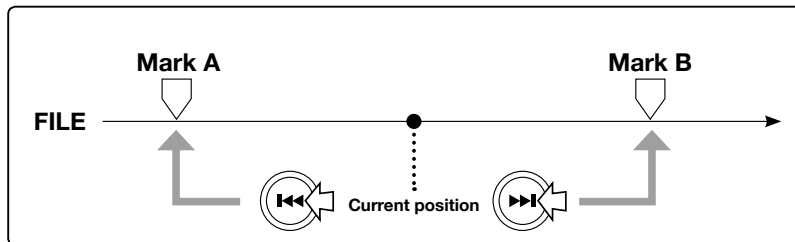

NOTE:

- Mark function is available only in case of WAV format.
- The maximum marks you can place in one file are 99.
- Once a mark has been created it cannot be deleted.

HINT:

- Pressing [REC] button during recording, you can create marks.
- You can recognize marks in the file in the <MARK LIST>.



Ref. <MARK LIST> **P.115**

4-04 Playback : <AB REPEAT>

The <AB REPEAT> repeat setting allows you to playback two points on the file repeatedly.

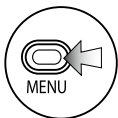
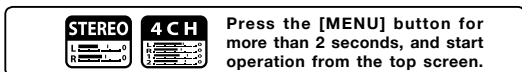

1 Press.



2 Select <TOOL> and press.

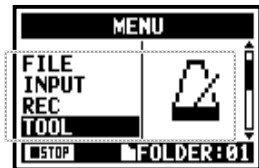

3 Select <AB REPEAT > and press.

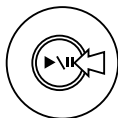
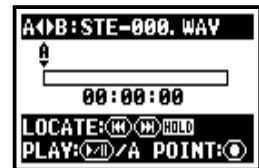
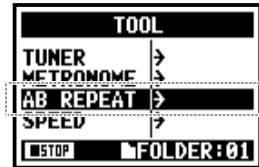

4 [START PLAYBACK] Press.

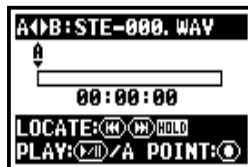

point A moves.

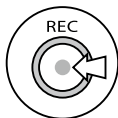

5 [Set up point A] Press.

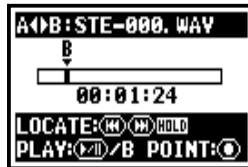

A mark is placed at point A, then mark B appears and moves until set

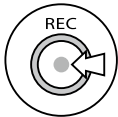

6 [Set up point B] Press.



Playback continues repeatedly between the indicated locations.

HINT:

You can set point [A] and [B] while stopped.

HINT:

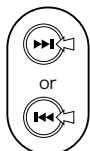

Movable with a long press.

Caution:

When you move around in the file using [FF] and [REW] buttons and whenever you press the button for less than 2 seconds (quick press), it will move to the next file. If there is a mark, it will move to the marked point.

By pressing the [FF] and [REW] buttons for more than 2 seconds you can move to a desired point.

After setting up A and B points press the [REC] button, you can cancel all settings.

NOTE:

During recording and playback, you cannot make any settings after Step 3 of <AB REPEAT>.

<AB REPEAT>

FIX/CLEAR of A & B point	
STOP	
PLAYBACK/TEMPORARY STOP of the file	
Holding the key for more than one second, operate wind-forward and rewind	
Just press the button, and move back or forward to the file * However if there is a marker in a WAV file, the button moves to the marking place.	

4-05 Playback : <SPEED>

You can adjust playback speed of the file.

Playback : <SPEED>

 Press the [MENU] button for more than 2 seconds, and start operation from the top screen.

"Short cut"
Pressing TRACK [3] on the top screen.

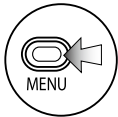

1 Press.



2 Select <TOOL> and press.

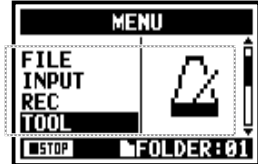

3 Select <SPEED> and press.

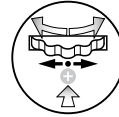
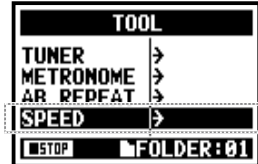

4 Adjust playback speed.



You can set up playback speed between 50% and 150% with increments or decrements of 5%.

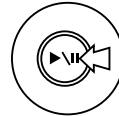

5 [START PLAYBACK] Press.

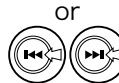
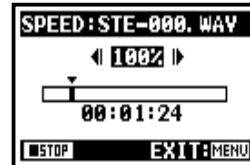

NOTE:

During recording and playback, you cannot make any settings after Step 3 of <SPEED>.

HINT:

- You can move swiftly to this menu pressing TRACK [3] button on the top screen of each mode.
- You can set up playback speed between 50% and 150% with increments or decrements of 5%. (Default; 100%)
- You can move the playback location using [FF] [REW] button.

4-06 Playback : <MIXER>

In 4CH mode you can use the mixer to adjust the playback LEVEL and PAN settings of two stereo files.



Press the [MENU] button for more than 2 seconds, and start operation from the top screen.

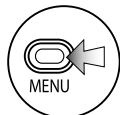

1 Press.



2 Select <MIXER> and press.

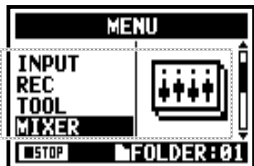

<LEVEL> setting

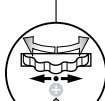

MUTE
48.0dB_+12.0dB
Default: -0.0dB

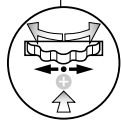

after setting, confirm with the icons

<PAN> setting

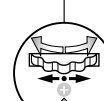

L 100 _ C _ R 100
Default: Center

Indicates if you are modifying the MIC or Input tracks

name of parameter where the cursor is positioned and its setting value

fader icon

pan pod icon

the cursor setting the parameter

4-07 Playback : Playback files (MTR mode)

There are various ways to playback in MTR mode: Create and record files separately, assign them to tracks and play them back simultaneously.

Playback : Playback files (MTR mode)

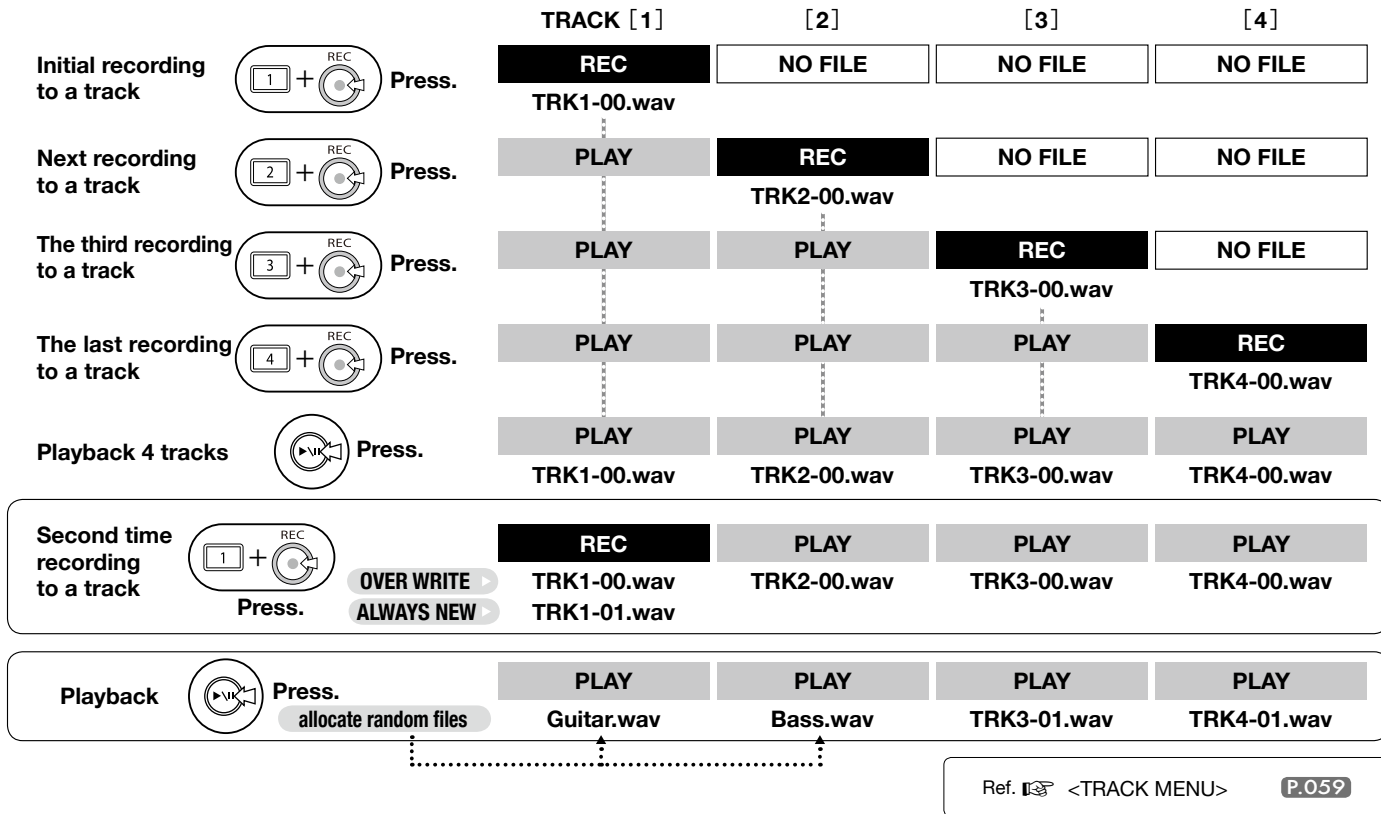

4-08 Playback : Appointing time with a counter

Using the counter, you can scroll to any desired point in a recording.

 Press the [MENU] button for more than 2 seconds, and start operation from the top screen.

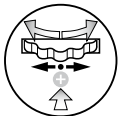

1 Select the counter figures on the top screen and press.

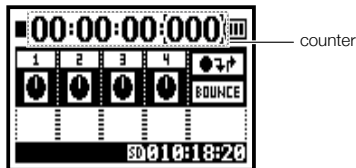

HINT

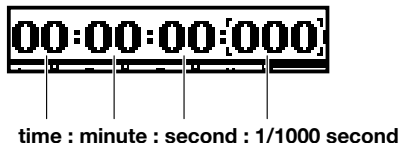

2 Set the time: Select the figures according to the appointing hour / minute / second.

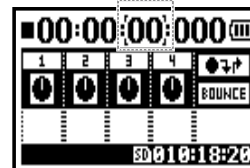

3 Change the figures and press.

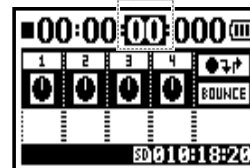

5-01 Edit / Output : <FOLDER SELECT>



Select the folder that contains your targeted file.

Edit / Output : <FOLDER SELECT>

   Press the [MENU] button for more than 2 seconds, and start operation from the top screen.

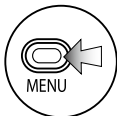

1 Press.



2 Select <FOLDER> and press.

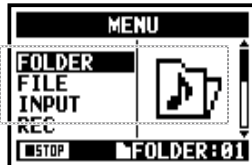

"Short cut"

Pressing TRACK [1] on the top screen.

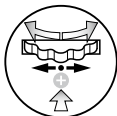

3 Select an optional folder and press.

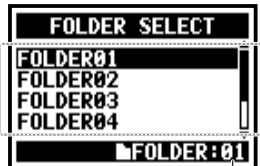

present folder

NOTE:

- You cannot use this setting during recording and playback.
- You can select any one separately among 10 folders in STEREO/ STAMINA and 4CH mode.

HINT:

You can call the <FOLDER SELECT> pressing TRACK [1] button on the top screen.

5-02 Edit / Output : <FILE SELECT>



Selecting playback files from the file list.

Press the [MENU] button for more than 2 seconds, and start operation from the top screen.

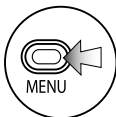

1 Press.

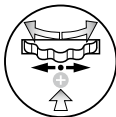

2 Select <FILE> and press.

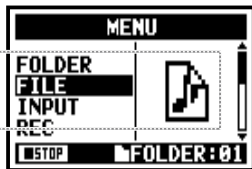

"Short cut"

Pressing TRACK [2] on the top screen.



3 Select an optional file and press.



▶ <FILE> operation to here is the same



4 Select <SELECT> and press.

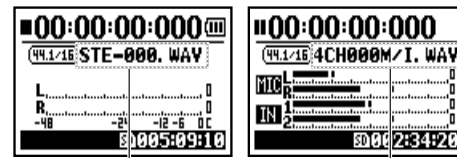

Verify the file name.

HINT:

- You can select files in the folder directly using [DIAL] from the top screen.
- You can move to step 3 <FILE SELECT> pressing TRACK [2] button on the top screen.

5-03 Edit / Output : <FILE INFORMATION>



This function displays the selected file information.

Edit / Output : <FILE INFORMATION>

SELECTING THE FILES...P.104 <FILE SELECT>

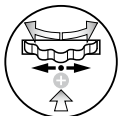

4 Select <INFORMATION> and press.



NAME	Name of the file
DATE	The recorded date of the file, or the renewal date when it created by PC or other device.
FORMAT	The format of the file. * On MTR Mode, display is either MONO or STEREO.
SIZE	Capacity of the file. (kB or MB)
TIME	The recording time of the file.

5-04 Edit / Output : <FILE DELETE>



Delete a selected file.

SELECTING THE FILES...P.104 <FILE SELECT>

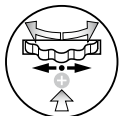

4 Select <DELETE> and press.



5 Select <YES> and press.



NOTE:

Caution;

Once deleted, you cannot retrieve the file.

5-05 Edit / Output : <FILE DELETE ALL>



Delete all the files in the folders and projects.

Edit / Output : <FILE DELETE ALL>

SELECTING THE FILES...P.104 <FILE SELECT>



4 Select <DELETE ALL> and press.



5 Select <YES> and press.



The name of the folder or the project to delete files.

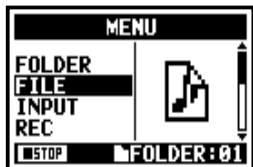

NOTE:

Once deleted, you cannot retrieve the file.

5-06 Edit / Output : <FILE (COPY)>

In MTR mode you can copy files. The copies are saved in the same project as the original files. This function is useful when you want to preserve the original master copy.

 Press the [MENU] button for more than 2 seconds, and start operation from the top screen.

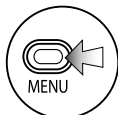

1 Press.



2 Select <FILE> and press.

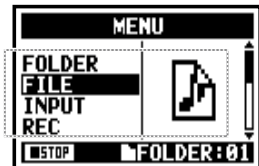

3 Select your desired file and press.



4 Select <COPY> and press.



5 Select <EXECUTE> and press.



HINT:

Change the file name: The default name given to copied files is "COPY-XXX". You can change that if necessary.



Ref.  <FILE RENAME>
P.109

5-07 Edit / Output : <FILE RENAME>

In STEREO, MTR and STAMINA MODE, you can change the name of the file.
When recorded in 4CH MODE, the file names cannot be changed.

SELECTING THE FILES...P.104 <FILE SELECT>

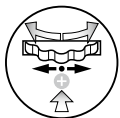

4 Select <RENAME> and press.



6 [Input a letter or number.]
Select.



select the letter with [DIAL]



5 [Make change of each letter or number.]
Select and press.



select the letter to be changed



7 Press.



press the [DIAL] and then the change is confirmed



press the [DIAL] and then the letter is reversed



8 Select <OK> and press.



HINT:

Display when the file name is over 12 characters.

When the name of the file has more than 12 letters, a triangle mark appears telling letters available outside the screen.

When converting letters, follow the next order:

(space)!#\$\$%&'()+,-01234
 56789;=@ABCDEFGHIJ
 KLMNOPQRSTUVWXYZ
]^_`abcdefghijklmnopqrstuvwxyz
 ~

NOTE:

In case of two files with the same name. The display shows "This file name already exists!", the screen returns to the previous one and you will need to create a different name.



5-08 Edit / Output : <FILE MP3 ENCODE>

In STEREO MODE you can encode a WAV FILE into MP3 format at various bit rates.

Edit / Output : <FILE MP3 ENCODE>

SELECTING THE FILES...P.104 <FILE SELECT>



4 Select <MP3 ENCODE> and press.

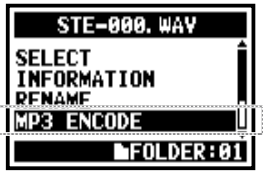

5 Select <BIT RATE> and press.

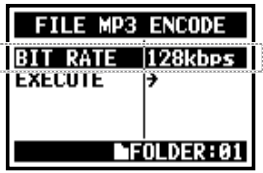

6 Select your desired bit rate and press.

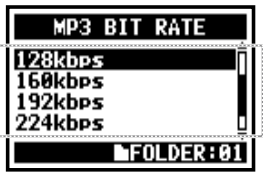

7 Select <EXECUTE> and press.

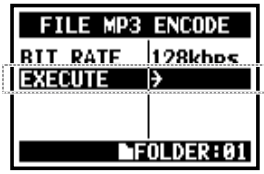

HINT:

- The name of the encode-completed file becomes automatically the "Original file name.mp3"
- You cannot have two files with the same name. When the screen says "The file name already exists!", select <RENAME> and create a different name.

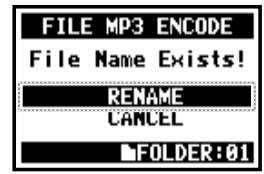

Bit rate that can be selected unit : kbps	48, 56, 64, 80, 96, 112, 128, 160, 192, 224, 256, 320, VBR Default; 128 kbps
---	--

5-09 Edit / Output : <FILE NORMALIZE>



This function automatically adjusts the volume level of a recorded file for enhanced sound quality and audio consistency.

SELECTING THE FILES...P.104<FILE SELECT>

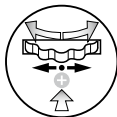

4 Select <NORMALIZE> and press.

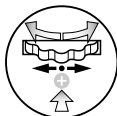

5 Select <YES> and press.



NOTE:

<NORMALIZE> function is only available for files recorded in WAV format

5-10 Edit / Output : <FILE STEREO ENCODE>

This function will mix down a 4CH file to a stereo file. The resulting files are stored in the folder in STEREO mode.

SELECTING THE FILES...P.104 <FILE SELECT>

Select <STEREO ENCODE>



4 Select <STEREO ENCODE> and press.



Set up <MIXER>: You should select to make MIXER settings effective when you start encoding.

5 Select <MIXER> and press.

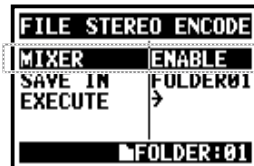

6 Select and press.

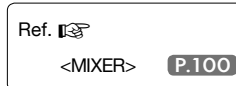
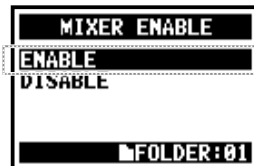

ENABLE	means to make setting effective.
DISABLE	means to inactivate setting, in other words mix two files 1:1

Select <SAVE IN>

Select the folder on STEREO mode to save the encoded files.

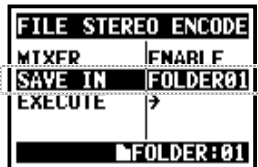
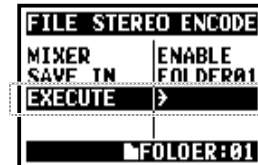
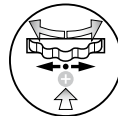
**7** Select <SAVE IN> and press.**8** Select the <SAVE IN> folder and press.**EXECUTION****9** Select <EXECUTE> and press.**HINT:**

You cannot have two files with the same name. If the screen says "File name exists!", select <RENAME> and set up a different name.

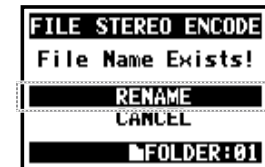

The encoded files are stored in the folder.

The file name automatically given is the same as the one on 4CH mode but M/I is changed to MIX.

Ref. 

<FILE RENAME> P.109

5-11 Edit / Output : <MARK LIST>



You can view the list of marks put in the WAV FILE.

SELECTING THE FILES...P.104 <FILE SELECT>

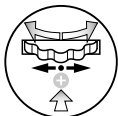

4 Select <MARK LIST> and press.



— This mark shows sounds dropout happening.

— The mark the user created.

NOTE:

The H4n will place the mark on the point automatically when sound dropout happens during recording.

HINT:

When there are no marks on the required files, the display will show "No Mark!".



Sound dropout (skipping) of a SD card

When you transfer the recorded data to a SD card, sometimes the speed of processing does not go in time and Sound dropout happens.

The speed of processing is different depend on mode, kind of <REC FORMAT>, type of SD card, etc. If the processing work is light, Sound dropout hardly happens,

and when the work is heavy, it often happens. In that case, change <REC FORMAT> to lighter.

	STEREO MODE	4CH MODE
Heavy ▲	WAV96kHz/24bit WAV96kHz/16bit	WAV48kHz/24bit WAV44.1kHz/24bit WAV48kHz/16bit WAV44.1kHz/16bit
▼ Light	WAV48kHz/24bit WAV44.1kHz/24bit WAV48kHz/16bit WAV44.1kHz/16bit MP3	

Ref.

<REC FORMAT> P.051
Setting the mark P.096

5-12 Edit / Output : <DIVIDE>

On STEREO MODE, you can divide files at any desired position.

SELECTING THE FILES...P.104 <FILE SELECT>

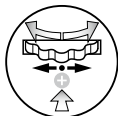



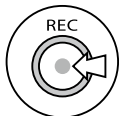

4 Select <DIVIDE> and press.

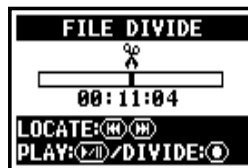

6 [DIVIDE POSITION]
You should press at the desirable dividing spot.



Operation of button on <DIVIDE>

DIVIDE	
PLAYBACK or TEMPORARY STOP of the file	
Holding the button for more than one second 'HOLD'. WIND-FORWARD and REWIND	
Moves for one second. The marked file moves to the 'MARK'. (Just press)	

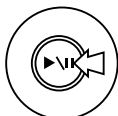

5 [START PLAYBACK]
Press.

Up: the current position in the file.

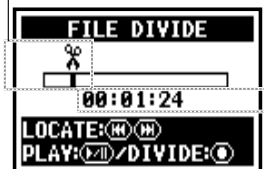

Below: the current time in the file.



7 Select <Yes> and press.

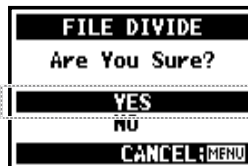

HINT:

- After the <DIVIDE> operation, there will be 2 files: the first portion will get [A] and the second one will get [B] at the end of the file name.



5-13 Edit / Output : <MOVE>



This function is used to move files to a different folder or mode.

SELECTING THE FILES...P.104 <FILE SELECT>



4 Select <MOVE> and press.



5 Select <MOVE TO> and press.

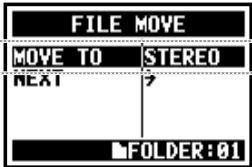

6 Select the moving mode.



7 Select <NEXT> and press.

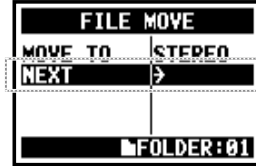

8 Select the moving folder(project).



Ref.
 <NEW PROJECT> P.118
 <FILE RENAME> P.109

NOTE:

MOVABLE FILE FORMAT

- Only stereo files can move to stereo folder. Monaural files cannot move to the stereo folders.
- Only 4CH files can move to 4CH folders.
- Moving to the MTR project you need 44.1 kHz/16bit format.
- If you try to move the files in the other format, the screen says, "44.1 kHz/16 bit WAV Format Only!".



MOVE TO MTR FOLDER

To move to the folders on MTR mode, the project folders must be prepared. If there is no project folder, The screen says "No Project!".



5-14 Edit / Output : <NEW PROJECT>

Here you can make a new project and adjust settings for AUDIO TRACK or EFFECT in MTR mode.



Press the [MENU] button for more than 2 seconds, and start operation from the top screen.



1 Press.



2 Select <PROJECT> and press.

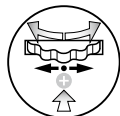
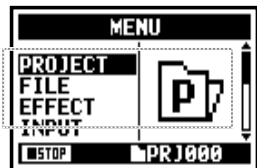

3 Select <NEW PROJECT> and press.



4 SELECT <EXECUTE> and press.



HINT:

To change the name of the new project.



Select <NAME> and

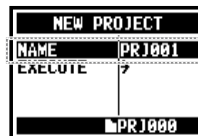

Select the letter to change and press.



Select <OK> and press.



Numbering of the projects

- The H4n numbers new projects automatically.
- You cannot change the number.
- You can use the same name in multiple projects

The maximum number of the projects

You can create a maximum of 1000 projects. Each project name can be up to 8 letters long.

(space)!"#\$%&'()*+,-./0123456789;<=>?@ABCDEF
GHIJKLMNOPQRSTUVWXYZ[\]^_`abcdefghijklmnopqrstuvwxyz{|}~

When you change letters, you can change in the above-mentioned order:

5-15 Edit / Output : <PROJECT (SELECT) >

Select a project stored on the SD card.

 Press the [MENU] button for more than 2 seconds, and start operation from the top screen.

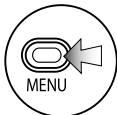

1 Press.



2 Select <PROJECT> and press.

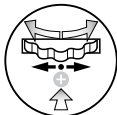
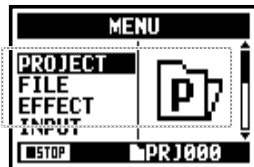

3 Select <SELECT> and press.



4 Select your desired project and press.

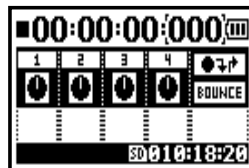

5-16 Edit / Output : <PROJECT (DELETE) >

This function will delete a project.

 Press the [MENU] button for more than 2 seconds, and start operation from the top screen.

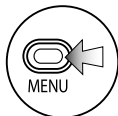

1 Press.

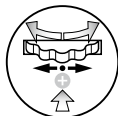

2 Select <PROJECT> and press.

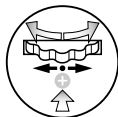
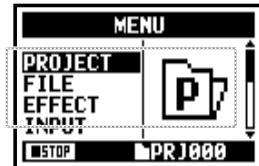

3 Select <DELETE> and press.



4 Select a project to be deleted and press.

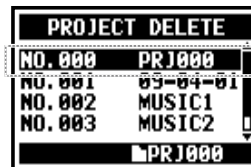

5 Select <YES> and press.

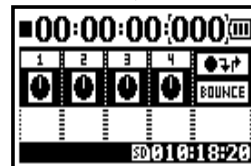

NOTE:

Once deleted, you cannot retrieve the project.

HINT:

You cannot delete a project under protection. You need to release it from protection before delete operation.

Ref.  <PROTECT> P.125

5-17 Edit / Output : <PROJECT (RENAME) >

You can change the name of the project.

 Press the [MENU] button for more than 2 seconds, and start operation from the top screen.

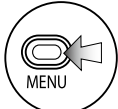

1 Press.



2 Select <PROJECT> and press.

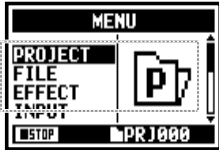

3 Select <RENAME> and press.



4 Select the project to change the name and press.

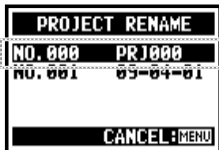

5 Select the letter to change and press.



6 Change the letter and press.

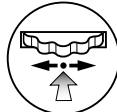

7 Select <OK> and press.



When you change letters, you can change in the following order:

(Space)!"#%&'()*+,-./0123456789;<=>
 ?@ABCDEFGHIJKLMNPOQRSTUVWXYZ
 Z[\]^_`abcdefghijklmnopqrstuvwxyz{}`

HINT:

Project number;

- The H4n numbers new projects automatically.
- You cannot change the number.
- You can use the same name in multiple projects.

5-18 Edit / Output : <PROJECT (COPY) >

Copy the project and create a new project with a new number.

Select a target project and start operation....P.119

 Press the [MENU] button for more than 2 seconds, and start operation from the top screen.

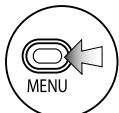

1 Press.

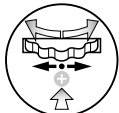

2 Select <PROJECT> and press.

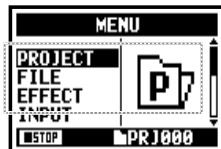

3 Select <COPY> and press.



4 Select <EXECUTE> and press.



HINT:

Change the number of the target project

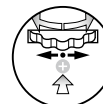

Automatically displays the lowest unused number

Change the name of the target project.

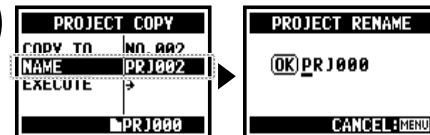

Ref.  <PROJECT(RENAME)> P.121

5-19 Edit / Output : <PROJECT (BOUNCE) >

You can combine tracks created in MTR mode and mix them down to one mono or stereo track.

Select a target project and start operation....P.119



Press the [MENU] button for more than 2 seconds, and start operation from the top screen.

Select <BOUNCE>



1 Select <BOUNCE> on the top screen and press.

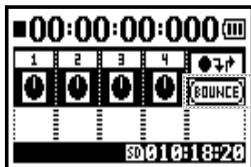

Select the name to bounce to. * If you have no change, proceed to next.→



2 Select <NAME> and press.

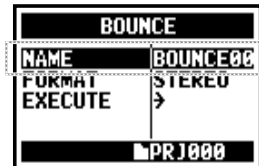

when you do not change the name, automatically given a file name: BOUNCE XX



3 Change the name of the file.

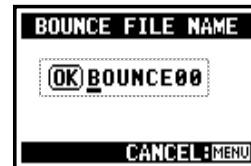

Ref. <FILE RENAME>

P.109

Select output file format: mono or stereo

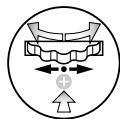

4 Select <FORMAT> and press.

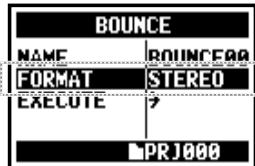

5 Select the file type and press.



STEREO	STEREO file
MONO	MONAURAL file

Execution



6 Select <EXECUTE> and press.

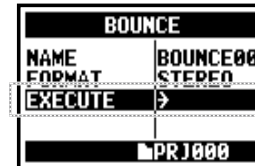

HINT:

BOUNCE means to put together the various music data divided in different tracks and files into the stereo or monaural files.

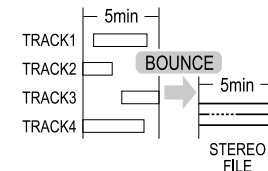

If you make <BOUNCE> operation, a new file will be created in the same project.

NOTE:

You cannot use this setting during recording and playback.

5-20 Edit / Output : <PROJECT (PROTECT) >

Using the PROTECT function on your project prohibits dividing of tracks and the change of files in that project.

Select a target project and start operation....P.119



Press the [MENU] button for more than 2 seconds, and start operation from the top screen.

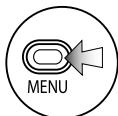

1 Press.

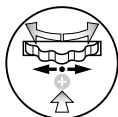

2 Select <PROJECT> and press.

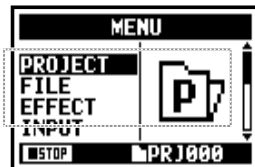

3 Select <PROTECT> and press.



4 Select <ON> and press.

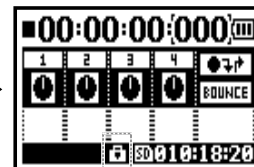
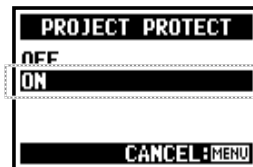

The mark shows the protected projects.

NOTE:

If you try to change a file allocated in a track, the screen will say "Project Protected".



HINT:

<PROTECT> is useful protection against the case when the setting of the completed music might be changed mistakenly.

6-01 Utility : <DISPLAY BACK LIGHT>



You can set the lighting time of the LCD BACK LIGHT on the display.

Press the [MENU] button for more than 2 seconds, and start operation from the top screen.

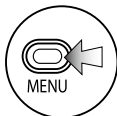

1 Press.



2 Select <SYSTEM> and press.

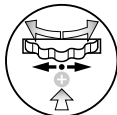
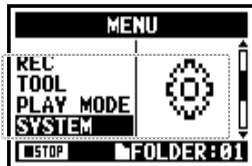

3 Select <LIGHT> and press.



4 Select the time you desire and press.



OFF	Switch off the light all the time.
ON	Switch on the light all the time.
15sec	Light on for 15 seconds after the last key operation.
30sec	Light on for 30 seconds after the last key operation.

* default; 15 seconds.

NOTE:

You cannot use this setting during recording and playback.

6-02 Utility : <DISPLAY CONTRAST>



Adjust the display contrast.

Utility : <DISPLAY CONTRAST>

Press the [MENU] button for more than 2 seconds, and start operation from the top screen.

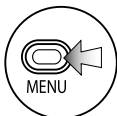

1 Press.

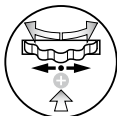

2 Select <SYSTEM> and press.

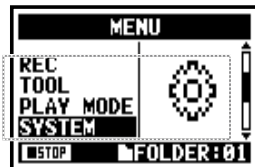

3 Select <CONTRAST> and press.



4 Change the number and press.



* You can adjust from #1 to #8. A higher the number corresponds to more contrast.

1	weak	get lighter
		↑
8	strong	get darker
		↓

* default; #5

NOTE:

You cannot use this setting during recording and playback.

6-03 Utility : <BATTERY TYPE>



By setting your battery type, H4n can correctly display the remaining lifetime of the battery.

Press the [MENU] button for more than 2 seconds, and start operation from the top screen.

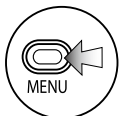

1 Press.



2 Select <SYSTEM> and press.

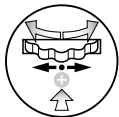
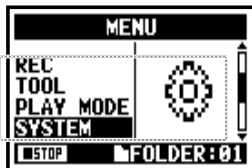

3 Select <BATTERY> and press.



4 Select the battery type and press.

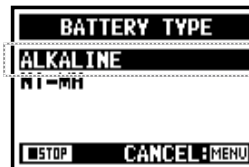

ALKALINE	Alkaline battery
Ni-MH	Nickel hydrogen storage battery

* Default; ALKALINE

NOTE:

Battery that can be used.

- Please use the alkaline or the nickel hydrogen storage battery.
- You cannot use this setting during recording and playback.

6-04 Utility : <VERSION>



After it starts, the version of H4n can be confirmed.

Utility : <VERSION>

Press the [MENU] button for more than 2 seconds, and start operation from the top screen.

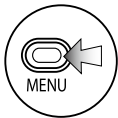

1 Press.



2 Select <SYSTEM> and press.

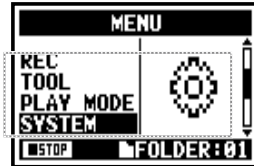

3 Select <VERSION> and press.



system version

boot program version

NOTE:

You cannot use this setting during recording and playback.

6-05 Utility : <FACTORY RESET>



Returns all the settings back to the original default condition.

Press the [MENU] button for more than 2 seconds, and start operation from the top screen.

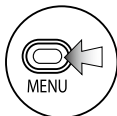

1 Press.



2 Select <SYSTEM> and press.

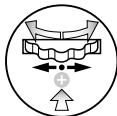
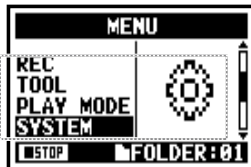

3 Select <FACTORY RESET> and press.



4 Select <YES> and press.



NOTE:

- You cannot use this setting during recording and playback.
- Caution: if you operate the <FACTORY RESET>, all the settings stored in this unit will be deleted and the settings will return to the original default condition.

6-06 Utility : <REMAIN>



You can confirm the remaining capacity of the SD CARD.

Utility : <REMAIN>

    Press the [MENU] button for more than 2 seconds, and start operation from the top screen.

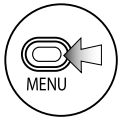

1 Press.



2 Select <SD CARD> and press.

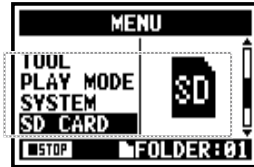

3 Select <REMAIN> and press.

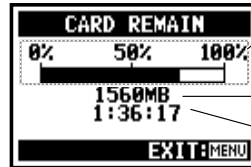
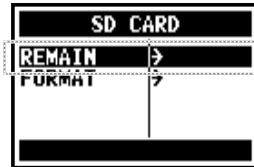

approximate remaining capacity

remain volume (MB)

Remaining recording time on the current recording format.

NOTE:

You cannot use this setting during recording and playback.

6-07 Utility : <FORMAT>



Formatting the SD card for the H4n.

Press the [MENU] button for more than 2 seconds, and start operation from the top screen.

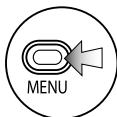

1 Press.



2 Select <SD CARD> and press.

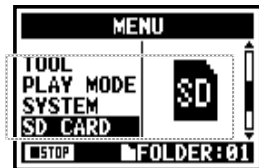

3 Select <FORMAT> and press.

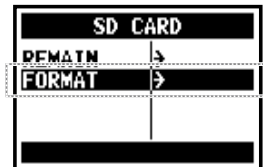

4 Select <YES> and press.



HINT:

“Format Card”

If you insert an SD card not formatted for the H4n, during boot up the unit says “Format Card?”

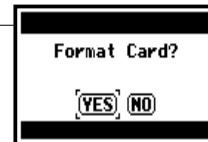

NOTE:

- You cannot use this setting during recording and playback.
- Caution: When you format the SD card, all data will be deleted.
- The SD cards used in a computer or a digital camera, should be formatted by the H4n before using.

Ref. SD card of H4 and H2 **P.134**

6-08 Utility : <VERSION UP>

If H4n (and SD card) is connected to the computer (PC) that has access to the internet, you can download H4n software upgrades.

1 PC * PC = computer (Windows and Macintosh)

Open Web site of ZOOM on PC and download the most recent system software. [<http://www.zoom.co.jp>]

You can verify H4n version at <SYSTEM (VERSION)>.



The version of the main body system

2 PC — H4n
Connect H4n to PC with USB cable.

To set-up connection of H4n and PC, connect with USB cable.

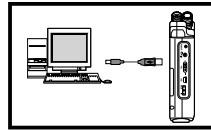

Connect H4n to PC with USB cable.

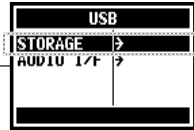

Select <STORAGE> and press.

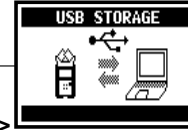

You can operate SD card data in H4n through PC.

3
The downloaded system software is copied onto the root directory of the SD card of H4n.

4 PC — H4n
Cancel the connection of PC and H4n.

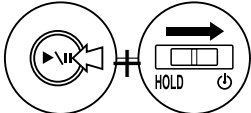
5 
Switch on while holding down PLAY/PAUSE button.



Select <OK> and press.



HINT:

Connect to a PC and select <STORAGE>. The H4n will be recognized as a SD card reader and you can make use of it.

NOTE:

Please disconnect through PC.

Ref. 

<SYSTEM(VERSION)>

P.129

6-09 Utility: How to use H2 and H4 SD cards

When you use the SD cards for H2 and H4 in the H4n, you can move their files and projects to the H4n.



1 Insert SD card for H2/H4 unit into H4n and boot up the unit.



2 Select **MOVE FILES** and **<YES>**, and press.

it is displayed for H4 as H4.

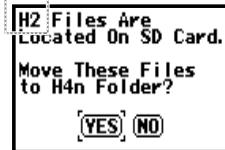

Start booting up

NOTE:

- The stereo files of H2/H4 and the projects of H4 will be moved to the H4n stereo folders and MTR projects.
- After moving to H4n, those SD cards are not recognized in H2/H4 unit.
- The projects move in order from the lowest numbered to the highest numbered project.
- When the H4n has more than 1000 projects in the unit after transfer, the unit says, "Project Full!" and stop moving.
- You must reduce the project number in H4n and continue the transfer.



HINT:

"File Name Exists!"

If there is the same file name in the moving folder, operate **<RENAME>** work.



Ref. < FILE RENAME >

P.109

Reference

Main spec list by mode

	STEREO MODE	4CH	MTR	STAMINA
Recording Format	STEREO WAV: 44.1/48/96kHz 16/24bit STEREO MP3: 48, 56, 64,80,96,112,128,160,192, 224,256, 320kbps, VBR44.1kHz	STEREO WAV × 2 : 44.1/48kHz 16/24bit	44.1kHz 16it STEREO WAV, MONAURAL WAV, those total 4 tracks can be combined	44.1 kHz/16bit WAV type only (fixed)
Maximum Track Numbers on Simultaneous Recording	2 tracks (STEREO 1 track)	4 Tracks (STEREO 2 Tracks)	2 tracks (STEREO 1 track, Monaural 2 tracks)	2 tracks (STEREO 1 track)
Limitation on File Capacity	2 GB * during STEREO and 4CH mode you should make a separate file when the recording capacity is over 2GB.			
File Making During Recording	Always save the initial one (impossible to overwrite)	Always save the initial one (impossible to overwrite)	Select either overwrite recording (save) or new recording (save)	Always save as the initial one (impossible to overwrite)
File Saving Place	Save in STEREO mode's very own 10 folders	Save in 4CH mode's very own 10 folders	Collect multiple numbers of files and control them as [PROJECT]	Save in STEREO mode's very own 10 folders
File Name Change	OK	Impossible	Impossible	OK
Folder Name Change	Impossible	Impossible	Impossible	Impossible
Marking Function	OK (WAV file only)	OK (WAV file only)	Impossible	OK (WAV file only)

Available setting menu list by each mode

SYSTEM	STEREO	4CH	MTR	STAMINA
DATE/TIME	△	△	△	△
BACK LIGHT	○	○	○	○
LCD CONTRAST	○	○	○	○
BATTERY TYPE	○	○	○	○
FACTORY RESET	△	△	△	△
SD CARD	STEREO	4CH	MTR	STAMINA
FORMAT	△	△	△	△
REMAIN	△	△	△	△
USB	STEREO	4CH	MTR	STAMINA
AUDIO IF	△	△	△	-
STORAGE	△	△	△	-
MODE	STEREO	4CH	MTR	STAMINA
MODE	△	△	△	-
FOLDER SELECT	STEREO	4CH	MTR	STAMINA
FOLDER SELECT	△	△	-	△
FILE	STEREO	4CH	MTR	STAMINA
FILE INFORMATION	△	△	△	△
FILE RENAME	△	△	△	△
FILE MP3 ENCODE	△	-	-	-
NORMALIZE	△	△	-	-
DIVIDE	△	-	-	-
MOVE	△	△	△	-
MARK LIST	△	△	-	△
FILE DELETE	△	△	△	△
FILE DELETE ALL	△	△	△	△
FILE STEREO ENCODE	-	△	-	-
FILE COPY	-	-	△	-

INPUT SETTING	STEREO	4CH	MTR	STAMINA
LO CUT	○	○	-	○
COMP/LIMIT	○	○	-	-
MONITOR	○	○	○	○
REC LEVEL AUTO	△	△	-	△
MONO MIX	△	-	-	△
MS STEREO MATRIX	○	○	-	-
PHANTOM	○	○	○	○
PLUG-IN POWER	○	○	○	○
REC SETTING	STEREO	4CH	MTR	STAMINA
REC FORMAT	△	△	-	-
AUTO REC	△	△	-	△
PRE REC	△	△	-	-
FILE NAME	△	-	-	△
TOOL	STEREO	4CH	MTR	STAMINA
TUNER	△	△	△	-
METRONOME*	○	○	○	-
A-B REPEAT	△	△	-	-
SPEED	△	-	-	-
PLAY MODE	STEREO	4CH	MTR	STAMINA
PLAY MODE	△	△	-	△
REC MODE	STEREO	4CH	MTR	STAMINA
REC MODE	-	-	△	-
EFFECT	STEREO	4CH	MTR	STAMINA
EDIT	-	-	○	-
IMPORT	-	-	△	-

PROJECT	STEREO	4CH	MTR	STAMINA
NEW PROJECT	-	-	△	-
SELECT	-	-	△	-
RENAME	-	-	△	-
COPY	-	-	△	-
DELETE	-	-	△	-
PUNCH IN/OUT	STEREO	4CH	MTR	STAMINA
PUNCH IN/OUT	-	-	○*	-
BOUNCE	STEREO	4CH	MTR	STAMINA
BOUNCE	-	-	△	-

○ ... You can use this setting during recording and playback. *** has the exception.

△ ... You cannot use this setting during recording and playback.

Effect types on MTR mode and the parameter

■ PREAMP module

● Guitar preamp effect types

FD CLEAN	Clean sound of Fender TwinReverb ('65)
VX CLEAN	Clean sound of Vox AC30
HW CLEAN	Clean sound of Hiwatt Custom 100
UK BLUES	Crunch sound of Marshall 1962 Bluesbreaker
BGcrunch	Crunch sound of Mesa Boogie MK
MS #1959	Crunch sound of Marshall 1959
PV DRIVE	High-gain sound of Peavey 5150
RECT VNT	High-gain sound using the red channel of Mesa Boogie Dual Rectifier (Vintage mode)
DZ DRIVE	High-gain sound of Diezel Herbert channel 3
TS+FDcmb	Combination of Fender Combo amp and Ibanez TS-9
SD+MSstk	Combination of Marshall stack amp and Boss SD-1
FZ+MSstk	Combination of FuzzFace and Marshall stack amp

The above 12 effect types have the same parameters.

(1) CABINET	0 – 2	Adjusts the intensity of the speaker cabinet sound.
(2) GAIN	0 – 100	Adjusts the preamp gain (distortion depth).
(3) BASS	-12 – 12	Adjusts boost/cut in the low range.
(4) MIDDLE	-12 – 12	Adjusts boost/cut in the middle range.
(5) TREBLE	-12 – 12	Adjusts boost/cut in the high range.
(6) LEVEL	1 – 100	Adjusts the level of the signal after passing the PRE-AMP module.
(7) ZNR (ZOOM Noise Reduction)	OFF, 1 – 16	Adjusts the sensitivity of the noise reduction circuit developed by ZOOM.

ACO SIM	This effect makes an electric guitar sound like an acoustic guitar.	
(1) TOP	0 – 10	Adjusts the characteristic string tone of the acoustic guitar.
(2) BODY	0 – 10	Adjusts the characteristic body tone of the acoustic guitar.
(3) BASS	-12 – 12	Adjusts boost/cut in the low range.
(4) MIDDLE	-12 – 12	Adjusts boost/cut in the middle range.
(5) TREBLE	-12 – 12	Adjusts boost/cut in the high range.
(6) LEVEL	1 – 100	Adjusts the level of the signal after passing the PRE-AMP module.
(7) ZNR (ZOOM Noise Reduction)	OFF, 1 – 16	Adjusts the sensitivity of the noise reduction circuit developed by ZOOM.

- Manufacturer names and product names mentioned in this table are trademarks or registered trademarks of their respective owners. The names are used only to illustrate sonic characteristics and do not indicate any affiliation with ZOOM CORPORATION.

● Bass preamp effect types

SVT	Simulation of Ampeg SVT sound.
BASSMAN	Simulation of Fender Bassman 100 sound.
HARTKE	Simulation of Hartke HA3500 sound.
SUP-Bass	Simulation of Marshall Super Bass sound.
SANSAMP	Simulation of Sansamp Bass Driver DI sound.
TUBE PRE	ZOOM original tube preamplifier sound.

The above 6 effect types have the same parameters.

(1) CABINET	0 – 2	Adjusts the intensity of the speaker cabinet sound.
(2) GAIN	0 – 100	Adjusts the preamp gain (distortion depth).
(3) BASS	-12 _ 12	Adjusts boost/cut in the low range.
(4) MIDDLE	-12 _ 12	Adjusts boost/cut in the middle range.
(5) TREBLE	-12 _ 12	Adjusts boost/cut in the high range.
(6) BALANCE	0 – 100	Sets the mixing balance between the signal before input and after passing the module. Higher values result in a higher ratio of post-module signal.
(7) LEVEL	1 – 100	Adjusts the level of the signal after passing the PREAMP module.
(8) ZNR (ZOOM Noise Reduction)	OFF, 1 – 16	Adjusts the sensitivity of the noise reduction circuit developed by ZOOM.

- Manufacturer names and product names mentioned in this table are trademarks or registered trademarks of their respective owners. The names are used only to illustrate sonic characteristics and do not indicate any affiliation with ZOOM CORPORATION.

● Mic preamp effect types

VO MPRE	Preamp with characteristics optimized for vocals.
AG MPRE	Preamp with characteristics optimized for recording an acoustic guitar.
FlatMPRE	Preamp with flat characteristics.

The above 3 effect types have the same parameters.

(1) COMP	OFF, 1 – 10	Adjusts the parameter which keeps the level within a certain range by attenuating high-level signals and boosting low-level signals.
(2) DE-ESSER	OFF, 1 – 10	Adjusts the degree by which sibilants are attenuated.
(3) LOW CUT	OFF, 1 – 10	Adjusts the frequency of a filter designed to attenuate low-frequency noise that is easily picked up by a mic.
(4) BASS	-12 – 12	Adjusts boost/cut in the low range.
(5) MIDDLE	-12 – 12	Adjusts boost/cut in the middle range.
(6) TREBLE	-12 – 12	Adjusts boost/cut in the high range.
(7) LEVEL	1 – 100	Adjusts the level of the signal after passing the PREAMP module.
(8) ZNR (ZOOM Noise Reduction)	OFF, 1 – 16	Adjusts the sensitivity of the noise reduction circuit developed by ZOOM.

Effect types on MTR mode and the parameter

■ EFX module

● Compressor/limiter effect types

RackComp	This is a compressor which attenuates high-level signals and boosts lowlevel signals.	
(1) THRESHOLD	0 – 50	Adjusts the threshold level of the compressor.
(2) RATIO	1 – 10	Adjusts the compression ratio of the compressor.
(3) ATTACK	1 – 10	Adjusts the attack speed of the compressor.
(4) LEVEL	2 – 100	Adjusts the level of the signal after passing the EFX module.
LIMITER	This is a limiter which attenuates high-level signals that exceed a certain threshold.	
(1) THRESHOLD	0 – 50	Adjusts the threshold level of the limiter.
(2) RATIO	1 – 10	Adjusts the compression ratio of the limiter.
(3) RELEASE	1 – 10	Adjusts the speed of the limiter release after the signal falls below the threshold level.
(4) LEVEL	2 – 100	Adjusts the level of the signal after passing the EFX module.

● Modulation effect types

AUTO WAH	This is an auto wah effect that tracks the input signal intensity.	
(1) POSITION	Before, After	Selects the insertion position of the EFX module: "Before" the PREAMP module or "After" the PREAMP module.
(2) SENSE	-10 – -1, 1 – 10	Adjusts the effect sensitivity.
(3) RESONANC	0 – 10	Adjusts the resonance characteristic of the effect.
(4) LEVEL	2 – 100	Adjusts the level of the signal after passing the EFX module.
PHASER	This effect produces sound with a pulsating character.	
(1) POSITION	Before, After	Selects the insertion position of the EFX module: "Before" the PREAMP module or "After" the PREAMP module.
(2) RATE	0 – 50, ♪ Ref. P144	Adjusts the modulation rate.
(3) COLOR	4STAGE, 8STAGE, INVERT 4, INVERT 8	Selects the sound type of the effect.
(4) LEVEL	2 – 100	Adjusts the level of the signal after passing the EFX module.
TREMOLO	This effect periodically varies the volume.	
(1) DEPTH	0 – 100	Adjusts the modulation depth.
(2) RATE	0 – 50, ♪ Ref. P144	Adjusts the modulation rate.
(3) WAVE	UP 0 – 9, DOWN 0 – 9, TRI 0 – 9	Allows selection of the modulation waveform. Available settings are UP (rising sawtooth), DOWN (falling sawtooth), and TRI (triangle). Higher setting values result in more clipping of wave peaks, which reinforces the effect.
(4) LEVEL	2 – 100	Adjusts the level of the signal after passing the EFX module.

RING MOD	This effect produces a metallic ringing sound. Adjusting the FREQUENCY drastic change of sound character.	
(1) POSITION	Before, After	Selects the insertion position of the EFX module: "Before" the PREAMP module or "After" the PREAMP module.
(2) FREQ	1 – 50	Adjusts the modulation frequency.
(3) BALANCE	0 – 100	Adjusts the balance between original sound and effect sound.
(4) LEVEL	2 – 100	Adjusts the level of the signal after passing the EFX module.

SLOW ATK	This effect softens the attack rate of each note, resulting in a violin playing style sound.	
(1) POSITION	Before, After	Selects the insertion position of the EFX module: "Before" the PREAMP module or "After" the PREAMP module.
(2) TIME	1 – 50	Adjusts the rise time.
(3) CURVE	0 – 10	Adjusts the attack volume change curve.
(4) LEVEL	2 – 100	Adjusts the level of the signal after passing the EFX module.

CHORUS	This effect mixes a variable pitch-shifted component to the original signal, resulting in full-bodied resonating sound.	
ENSEMBLE	This is a chorus ensemble with three-dimensional movement.	

The above 2 effect types have the same parameters.

(1) DEPTH	0 – 100	Adjusts the modulation depth.
(2) RATE	1 – 50	Adjusts the modulation rate.
(3) TONE	0 – 10	Adjusts the tone.
(4) MIX	0 – 100	Adjusts the level of effect sound mixed to the original sound.

FLANGER	This effect produces a resonating and strongly undulating sound.	
(1) DEPTH	0 – 100	Adjusts the modulation depth.
(2) RATE	0 – 50,  Ref. P144	Adjusts the modulation rate.
(3) RESONANC	-10 – 10	Adjusts the resonance characteristic of the effect.
(4) MANUAL	0 – 100	Adjusts the frequency range in which the effect operates.

STEP	Special effect that changes the sound in a staircase pattern.	
(1) DEPTH	0 – 100	Adjusts the modulation depth.
(2) RATE	0 – 50,  Ref. P144	Adjusts the modulation rate.
(3) RESONANC	0 – 10	Adjusts the resonance characteristic of the effect. Adjusts the effect sound envelope.
(2) SHAPE	0 – 10	Adjusts the effect sound envelope.

VIBE	This is an automatic vibrato effect.	
(1) DEPTH	0 – 100	Adjusts the modulation depth.
(2) RATE	0 – 50,  Ref. P144	Adjusts the modulation rate.
(3) TONE	0 – 10	Adjusts the balance between original sound and effect sound.
(4) BALANCE	0 – 100	This effect varies the sound like a talking modulator.

Effect types on MTR mode and the parameter

CRY			This effect varies the sound like a talking modulator.
(1) RANGE	1 – 10	Adjusts the frequency range in which the effect operates.	
(2) RESONANC	0 – 10	Adjusts the resonance characteristic of the effect.	
(3) SENSE	-10 – -1, 1 – 10	Adjusts the effect sensitivity.	
(4) BALANCE	0 – 100	Adjusts the balance between original sound and effect sound.	

PITCH			This effect shifts the pitch up or down.
(1) SHIFT	-12 – 12, 24	Adjusts the pitch shift amount in semitones.	
(2) TONE	0 – 10	Adjusts the tone.	
(3) FINE	-25 – 25	Fine-adjusts the pitch shift amount in cent (1/100 semitone units).	
(4) BALANCE	0 – 100	Adjusts the balance between original sound and effect sound.	

● Delay/reverb effect types

AIR			This effect lends spatial depth to the sound by reproducing the ambient atmosphere of a room.
(1) SIZE	1 – 100	Adjusts the size of the simulated space.	
(2) REFLEX	0 – 10	Adjusts the amount of wall reflections.	
(3) TONE	0 – 10	Adjusts the tone.	
(4) MIX	0 – 100	Adjusts the level of effect sound mixed to the original sound.	

DELAY			This is a long delay of up to 5000 milliseconds.
ECHO			This simulates a tape echo with a long delay time of up to 5000 milliseconds.
ANALOG			This simulates a warm-sounding analog delay with a long delay time of up to 5000 milliseconds.

The above 3 effect types have the same parameters.

(1) TIME	1 – 5000ms,* ♪ Ref. P144	Adjusts the delay time.	
(2) FEEDBACK	0 – 100	Adjusts the feedback amount.	
(3) HIDAMP	0 – 10	Adjusts the delay sound damping characteristics in the high frequency range.	
(4) MIX	0 – 100	Adjusts the level of effect sound mixed to the original sound.	

* ms = milliseconds.

RvsDelay	This is a reverse delay with a long delay time of up to 2500 milliseconds.	
(1) TIME	10–2500 ms,* 	Adjusts the delay time. (Ref. P144)
(2) FEEDBACK	0 – 100	Adjusts the feedback amount.
(3) HIDAMP	0 – 10	Adjusts the delay sound damping characteristics in the high frequency range.
(4) BALANCE	0 – 100	Adjusts the balance between original sound and effect sound.

* ms = milliseconds.











HALL	This reverb effect simulates the acoustics of a concert hall.
ROOM	This reverb effect simulates the acoustics of a room.
SPRING	This effect simulates a spring reverb.
ARENA	This effect simulates a large venue such as an arena.
T ROOM	This effect simulates the acoustics of a tiled room.
M SPRING	This effect simulates a bright and clear sounding spring reverb.

The above 6 effect types have the same parameters.

(1) DECAY	1 – 30	Adjusts the reverb duration.
(2) PRE DLY	1 – 100	Adjusts the delay between the original sound and the start of the reverb sound.
(3)TONE	0 – 10	Adjusts the tone.
(4) MIX	0 – 100	Adjusts the level of effect sound mixed to the original sound.

[Table]

Parameters with a <♪> symbol can be selected in note units, using the metronome tempo as reference. Note durations

	Thirty-second note	 3	Half triplet note	 x 3	Quarter note x 3
	Sixteenth note		Dotted eighth note	⋮	⋮
 3	Quarter triplet note		Quarter note		
	Dotted sixteenth note		Dotted quarter note	⋮	⋮
	Eighth note	 2	Quarter note x 2		

NOTE:

- The actual note range that can be selected depends on the parameter.
- Some tempo and note symbol combinations may result in values that exceed the parameter range. In such a case, the value will automatically be set to 1/2. If this would still exceed the range, the value is set to 1/4.

H4n patch list

Effect patches in this page " Patch List" can be used in 4track mode and audio interface function. (with sampling rate in 44.1kHz)

Category	No.	Patch Name	Description	PREAMP module	EFX module
Guitar	00	Fender Clean	Basic clean sound optimized for recording.	FD CLEAN	OFF
	01	Natural Cho	Versatile clean chorus sound for applications ranging from arpeggio to melody playing.	OFF	ENSEMBLE
	02	FunkyCutting	Great sound for seventies style funky cutting.	FD CLEAN	AUTO WAH
	03	Clean Lead	Sound suitable for solo play, characterized by clean delay with a tempo setting of about 120 BPM.	HW CLEAN	DELAY
	04	Vox Clean	Mersey beat sound as exemplified by the Beatles using the Vox AC30TBX.	VX CLEAN	LIMITER
	05	Light AcoSim	Acoustic guitar simulation ideal for stroke playing.	ACO SIM	HALL
	06	Clean Comp	Natural compressor sound that differs from a conventional stomp box compressor.	FD CLEAN	RackComp
	07	CuttingPhase	Phaser with a wide range of applications for various cutting styles.	OFF	PHASER
	08	Smooth Trem	Tremolo sound that smoothly enhances everything from full notes to delicate arpeggios.	FD CLEAN	TREMOLO
	09	Deep Vibe	Vibrato sound provides body to sound effects and band sound.	OFF	VIBE
	10	Octave Down	Distorted unison sound adds a one octave lower component.	TS+FDcmb	PITCH
	11	MS Crunch	Marshall Bluesbreaker crunch sound that closely tracks your picking.	UK BLUES	RackComp
	12	Full Crunch	Simulation of the versatile Mesa Boogie Mk III for backing or lead.	BGcrunch	RackComp
	13	Air Crunch	Crunch sound with a light and airy feel.	UK BLUES	AIR
	14	Blues Tone	Solid backbone for lead parts in Blues and Rock'n Roll.	TS+FDcmb	ROOM
	15	Crossover	Overdrive tone with just the right chorus for Fusion and Crossover.	BGcrunch	ENSEMBLE
	16	Peavey Lead	High gain sound of Peavey 5150 fits power chords, speedy riffs, or technical solos.	PV DRIVE	OFF
	17	Diezel Riff	Heavy riff sound using a DIEZEL Herbert simulation.	DZ DRIVE	OFF
	18	Rectify Lead	Simulation of the Mesa Boogie Rectifier high-gain sound.	RECT VNT	RackComp
	19	Melody Line	Delay sound for playing everything from melody to improvised solos.	PV DRIVE	DELAY
	20	Classic MS	Sound modeled on the Marshall 1959 SuperLead 100.	MS #1959	ROOM
	21	Fuzz Box	Distinct fuzz tone using a combination of FUZZ FACE + Marshall sound.	FZ+MSstk	SPRING
	22	Air Lead	Mesa Boogie Mk III drive sound combines airiness with a gutsy touch.	BGcrunch	AIR
	23	Jet Flanger	Well-known jet sound makes chords more expressive.	SD+MSstk	FLANGER
24	Wah Lead	Heavy wah sound combining distortion and auto wah, suitable for lead play.	SD+MSstk	AUTO WAH	

Category	No.	Patch Name	Description	PREAMP module	EFX module	
Bass	25	Hartke	Tight sound modeled on the HARTKE HA3500.	HARTKE	OFF	
	26	Bassman	Standard bass sound inspired by the FENDER BASSMAN 100.	BASSMAN	OFF	
	27	SVT	Rock bass sound modeled on the AMPEG SVT.	SVT	OFF	
	28	SuperBass	Drive sound modeled on the MARSHALL 1992 SuperBass.	SUP-Bass	OFF	
	29	SANSAMP	Simulates the sound of the SANSAMP BASS DRIVER DI.	SANSAMP	OFF	
	30	Studio Pre	Straightforward tube preamp sound is highly versatile.	TUBE PRE	OFF	
	31	Pick Bass	HARTKE HA3500 sound optimized for picking.	HARTKE	OFF	
	32	Chorus Bass	Sound with chorus blend, suitable for melody playing.	BASSMAN	ENSEMBLE	
	33	Slap Comp	Compressor sound that allows free selection of styles, such as slap (chopper), picking and finger playing.	SVT	RackComp	
	34	Flange Bass	Flanging bass sound such as used in Fusion music.	TUBE PRE	FLANGER	
	Mic	35	StandardComp	Standard compressor optimized for recording.	FlatMPRE	RackComp
		36	Studio Comp	Compressor sound suitable for vocal recording.	VO MICPRE	RackComp
		37	Chorus Vocal	Deep chorus sound for solo vocals.	VO MICPRE	CHORUS
		38	Flange Vocal	Flanger sound for soothing pop music vocals.	VO MICPRE	FLANGER
39		Light Vocal	Effect sound for bright and articulate vocals.	FlatMPRE	ROOM	
40		Spring	Effect sound with effective use of spring reverb.	VO MPRE	SPRING	
41		Arena	Deep reverb sound as if singing in an arena.	VO MPRE	ARENA	
42		Doubling	Conventional doubling effect.	VO MPRE	DELAY	
43		Lead Vocal	Delay effect suitable for main vocal parts.	VO MPRE	DELAY	
44		Analog Echo	Vocal echo sound using an analog delay effect.	VO MPRE	ANALOG	
45		Reverse Trip	Trippy sound using a reverse delay.	VO MPRE	RvsDelay	
46		AG Reverb	Preamp + reverb combination optimized for mic recording of acoustic guitar.	AG MPRE	ARENA	
47		AG Arpeggio	Preamp + chorus combination optimized for mic recording of acoustic guitar (arpeggio play).	AG MPRE	CHORUS	
48		AG Ensemble	Preamp + ensemble combination optimized for mic recording of acoustic guitar (arpeggio play).	AG MPRE	ENSEMBLE	
49		AG Lead	Preamp + delay combination optimized for mic recording of acoustic guitar (lead play).	AG MPRE	DELAY	
50 - 59	EMPTY					

* Manufacturer names and product names mentioned in this patch list are trademarks or registered trademarks of their respective owners and do not indicate any affiliation with ZOOM CORPORATION. All product and artist names are intended only to illustrate sonic characteristics that were used as reference in the development of this product.

H4n products spec

Recorder		STEREO MODE	4CH MODE	MTR MODE
	Number of simultaneous recording tracks	2	4	2
	Number of simultaneous playback tracks	2	4	4
	Recording time	4GB (SDHC) Approx. 380 minutes (converted to WAV 44.1 kHz/16 bit stereo track) Approx. 68 hours (converted to MP3 44.1 kHz/128 kbps stereo track) * Recording times are approximations. Actual times may differ according to recording conditions.		
	Maximum number of simultaneous recording file size	2GB		
	Projects	1000/card		
	Locate function	Hours/Minutes/Seconds/Milliseconds		
Other functions	Punch-in/out, Bounce, A-B repeat			
Effects	Modules	2		
		STEREO MODE / 4CH MODE : LO CUT, COMP/LIMITER MTR MODE : PRE AMP module , EFX module		
	Types	50		
	Patches	60		
	Tuners	Chromatic, Guitar, Bass, Open A/D/E/G, DADGAD		
Metronome	Metronome sound sources	5		
	Variable beat	1/4 - 8/4, 6/8, unaccentuated		
	Tempo	40.0 - 250.0 BPM		
A/D conversion	24 bit	24 bit × 128 oversampling		
D/A conversion	24 bit	24 bit × 128 oversampling		
Recording media	SD card (16MB – 2GB) , SDHC card (4GB – 32GB)			
Data type	WAV Format			
	<Record/Play>	Quantization 16/24 bit		
		Sampling frequency 44.1/48/96 kHz		

Data type	MP3 Format	
	<Recording>	Bit rate 48, 56, 64, 80, 96, 112, 128, 160, 192, 224, 256, 320 kbps, VBR
		Sampling frequency 44.1 kHz
<Playback>	Bit rate 32, 40, 48, 56, 64, 80, 96, 112, 128, 160, 192, 224, 256, 320 kbps, VBR	
		Sampling frequency 44.1/48 kHz
Display	128 x 64 dots	Full-dot LCD (with backlight)
Inputs	INPUT [1] [2]	
	XLR (balanced input) / standard phone (unbalanced input) combo jack Input impedance (using balanced input) 1 k Ω balanced, pin 2 hot (using unbalanced input) 480 k Ω unbalanced Input level (using balanced input) -10 dBm _ -42 dBm (using unbalanced input) +2 dBm _ -32 dBm	
	Built-in stereo mic	Unidirectional condenser microphone Gain +7 dB _ +47 dB
Outputs	EXT MIC	
	Mini stereo phone jack Input impedance 2 k Ω Input level -7 dBm _ -47 dBm	
	L I N E / PHONE	LINE Output load impedance 10 k Ω or more Rated output level -10 dBm
	PHONE	20 mW+20 mW (into 32- Ω load)
	Monaural speaker 400 mW 8 Ω	
Phantom power supply	48 V, 24 V, OFF	
USB	USB2.0High Speed Mass Storage Class operation, Audio Interface operation USB functions can be operated by USB bus power	
Power requirements	DC 5 V 1A AC from AC adapter (ZOOM AD-14) , Batteries IEC R6 (size AA) × 2	
Continuous recording time	6 hours (Usually)	11 hours (STAMINA MODE)
Dimensions	73 (W) × 156.3 (D) × 35 (H) mm	
Weight	280 g	

* 0 dBm = 0.775 Vrms * Design and specifications subject to change without notice.

When you think something may be wrong with your machine

If there are problems during operation of the H4n, check the following points first.

Problems during recording/playback

◆ No sound, or sound is very weak

- Check the connections to your monitor system, and the volume setting of the system.
- Check whether the volume level setting of tracks 1 – 4 is appropriate.

◆ Recorder stops during playback

- When playback is carried out with a track in recording standby condition, a temporary file is created in the H4n. If the remaining capacity of the SD card is low, the temporary file may use up all the remaining space, causing playback to stop. In such a case, cancel the recording standby condition of the track.

◆ No sound from connected instrument, or sound is very weak

- Check input source settings (→P.047).
- Check setting of INPUT [1], INPUT [2], and [MIC] buttons. (→P.047).
- Check whether recording level setting is appropriate. (→P.047).
- If INPUT [1]/INPUT [2] jacks are used, try raising output level of connected instrument.
- When the monitor function (→P.071) is off, the input signal can only be monitored if a track is set to recording standby or if the recorder is in the recording standby condition.

◆ Cannot record on a track

- Verify that [REC] button and button for recording target track are lit in red.
- If a project is protected, recording is not possible. Use another project or turn protection off (→P.125).

- Verify that an SD card is inserted in the slot.
- Check whether the hold function is enabled (→P.020).
- If the indication "Card Protected" is shown on the display, the SD card is write-protected. Slide the write-protect switch to the non-protected position.

◆ Cannot perform bounce

- Verify that the level of tracks 1 – 4 is not fully lowered.
- Verify that there is sufficient free space on the SD card.

Other problems

◆ Cannot use effects

- Check whether effect section is on. The effect section is off by default in stereo mode and in 4-track mode.

◆ Cannot use tuner

- Check whether the jack to which the instrument is connected is selected as input source.

◆ Unit is not recognized when connected to a computer via USB

- Check whether the operating system of the computer meets the requirements listed on page 035.
- To have the H4n recognized by the computer, USB mode must first be selected at the H4n (→P.033).

[4CH MODE]

- Details ▶P37-39
- Mode and top screen ▶P41
- Mode selection ▶P37-38
- Playback operation ▶P94
- Recording operation ▶P53

[A]

- AB repeat ▶P97
- Always New recording mode ▶P58
- AUDIO I/F (Audio interface), use as ▶P33
- AUTO PUNCH IN/OUT ▶P61
- AUTO REC ▶P65
- AUTO REC STOP ▶P66

[B]

- Battery/Power outlet setting ▶P17
- BATTERY TYPE ▶P128
- Bit rate ▶P51
- BOUNCE ▶P123
- Built-in microphones ▶P30
- Built-in speaker ▶P36

[C]

- Copyright warnings ▶P7
- CANCEL operation ▶P25
- CARIB/TUNER ▶P77
- CHROMATIC/TUNER ▶P75
- COMP/LIMIT ▶P69
- Connections ▶P29

[D]

- DATE/TIME ▶P28
- DAW software ▶P34
- DIVIDE ▶P116
- [DIAL] use as ▶P25
- [DISPLAY]**
 - DISPLAY BACK LIGHT ▶P126
 - DISPLAY CONTRAST ▶P127

[E]

- [EFFECT] ▶P81 –**
 - EDIT ▶P84
 - EDIT (EFX) ▶P86
 - EDIT (LEVEL) ▶P87
 - EDIT (PRE AMP) ▶P85
 - EDIT (RENAME) ▶P87

- EDIT (STORE) ▶P88
- Effect types and parameters ▶P139
- Effects ▶P81
- IMPORT ▶P89
- Patch List ▶P145
- EFX module/EFFECT ▶P86

[F]

- FACTORY RESET ▶P130

[FILE]

- FILE (COPY) ▶P108
- FILE DELETE ▶P106
- FILE DELETE ALL ▶P107
- FILE INFORMATION ▶P105
- FILE MP3 ENCODE ▶P111
- FILE NAME ▶P52
- FILE NORMALIZE ▶P112
- FILE RENAME ▶P109
- FILE SELECT ▶P104
- FILE STEREO ENCODE ▶P113
- FILE/TRACK MENU ▶P59
- FOLDER SELECT ▶P103
- FORMAT ▶P132

[H]

- HOLD switch ▶P20

[I]

IMPORT/EFFECT ▶P89
 INPUT [MIC][1][2] buttons operations ▶P23
 INPUT/TUNER ▶P78

[K]**[KARAOKE]**

Preparation ▶P91
 Recording ▶P93
 Setting/TRACK MENU ▶P59

[L]

LEVEL/EFFECT ▶P87
 LEVEL/TRACK MENU ▶P59
 Locator buttons operations ▶P21
 LO CUT ▶P68

[M]

Manual PUNCH IN/OUT ▶P63
 MARK ▶P96
 MARK LIST ▶P115

[MENU]

MAIN MENU ▶P43

[MENU] button operations ▶P25
 METRONOME ▶P79
 MIXER ▶P100
 Mixing ▶P59
 MODE ▶P37–44
 MONITOR ▶P71
 MONO MIX ▶P72
 MOVE ▶P117
 MP3 ENCODE ▶P111
 MP3 file format ▶P51
 MS STEREO MATRIX ▶P73

[MTR MODE]

Always new recording mode ▶P58
 Mode and top screen ▶P42
 Mode selection ▶P38
 Over write recording mode ▶P57
 Playback operations ▶P101
 Recording operations ▶P55
 TRACK MENU ▶P59

[N]

NEW PROJECT ▶P118
 NORMALIZE ▶P112

[O]

Off-mic recording ▶P31

On-mic recording ▶P31
 Over write recording mode ▶P57

[P]

PATCH EDIT/EFFECT ▶P84
 Patch List ▶P145
 PAN/TRACK MENU ▶P59
 Phantom power ▶P32
 PLAY MODE ▶P95
 Plug-in power ▶P31
 POWER switch ▶P19
 Power On and Off ▶P19
 PRE AMP/EFFECT ▶P85
 PRE REC ▶P67

[PROJECT]

BOUNCE ▶P123
 COPY ▶P122
 DELETE ▶P120
 NEW PROJECT ▶P118
 RENAME ▶P121
 PROTECT ▶P125
 SELECT ▶P119
 PUNCH IN/OUT (Auto) ▶P61
 PUNCH IN/OUT (Manual) ▶P63

[R]

- REC FORMAT ▶P51
- REC LEVEL AUTO ▶P70
- REC LEVEL operations ▶P24
- [REC] button operations ▶P21
- Recording (stereo/stamina mode) ▶P49
- Recording (4CH mode) ▶P53
- Recording (MTR mode) ▶P55
- Recording track selection ▶P47
- REMAIN ▶P131
- Remote control (option) ▶P16-45
- RENAME/EFFECT ▶P87
- RENAME/FILE ▶P109
- RENAME/PROJECT ▶P121

[S]

- Safety precautions for users ▶P6
- Setting ▶P29

[SD CARD]

- Audio Interface, use as ▶P33
- H2, H4 SD card, use as ▶P134
- Checking available space on the SD card ▶P131
- SD card reader, use as ▶P35
- Software version upgrading ▶P133
- SPEED ▶P99

[STAMINA MODE]

- Details ▶P37,39
- Mode and top screen ▶P40
- Mode setting ▶P17-38
- Playback operation ▶P94
- Recording operation ▶P49

STEREO ENCODE ▶P113

[STEREO MODE]

- Details ▶P37-39
- Mode and top screen ▶P40
- Mode selection ▶P38
- Playback operation ▶P94
- Recording operation ▶P49

STEREO LINK ▶P60

STORAGE ▶P35-133

STORE/EFFECT ▶P88

[T]

TRACK MENU ▶P59

TRACK [1][2][3][4] buttons operations ▶P22

[TUNER]

- CARIB ▶P77
- CHROMATIC ▶P75
- GUITAR, OPEN G, DAGDAG ▶P76
- INPUT ▶P78
- TUNER types ▶P78

[U]

[USB connection]

- H4n used as a SD card reader ▶P35
- H4n used as an Audio Interface ▶P33
- USB bus power ▶P35

[V]

VOLUME operations ▶P24

WAV file format ▶P51

Write-protect ▶P125

The FCC regulation warning (for U.S.A.)

This equipment has been tested and found to comply with the limits for a Class B digital device, pursuant to Part 15 of the FCC Rules. These limits are designed to provide reasonable protection against harmful interference in a residential installation. This equipment generates, uses, and can radiate radio frequency energy and, if not installed and used in accordance with the instructions, may cause

harmful interference to radio communications. However, there is no guarantee that interference will not occur in a particular installation. If this equipment does cause harmful interference to radio or television reception, which can be determined by turning the equipment off and on, the user is encouraged to try to correct the interference by one or more of the following measures:

- **Reorient or relocate the receiving antenna.**
- **Increase the separation between the equipment and receiver.**
- **Connect the equipment into an outlet on a circuit different from that to which the receiver is connected.**
- **Consult the dealer or an experienced radio/TV technician for help.**

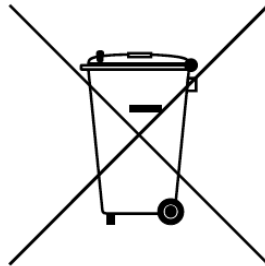

Disposal of Old Electrical & Electronic Equipment (Applicable in European countries with separate collection systems)

This symbol on the product or on its packaging indicates that this product shall not be treated as household waste. Instead it shall be handed over to the applicable collection point for the recycling of electrical and electronic equipment. By ensuring this product is disposed of correctly, you will help prevent potential negative consequences for the environment and human health, which could otherwise be caused by inappropriate waste handling of this product. The recycling of materials will help to conserve natural resources. For more detailed information about recycling of this product, please contact your local city office, your household waste disposal service or the shop where you purchased the product.

H4next
Handy Recorder

ZOOM
ZOOM CORPORATION

ITOHPIA Iwamotocho 2chome Bldg. 2F, 2-11-2, Iwamoto-cho,
Chiyoda-ku, Tokyo 101-0032, Japan
Web Site: <http://www.zoom.co.jp>

H4n-5000-2

This USB/Cubase LE 4 Startup Guide explains how to install Cubase LE 4 on a computer, make connections and settings for the H4n, and perform recording.

To connect the H4n to a computer running Windows Vista (or Windows XP) and to enable audio input/output, proceed as follows. The installation description uses Windows Vista as an example.

1 Download the latest ZOOM H4 ASIO driver from the web site of ZOOM Corporation (<http://www.zoom.co.jp>) and install the driver.

The ZOOM H4 ASIO driver software is required to enable use of Cubase LE 4 for audio input and output with a computer. Refer to the read_me file included in the download package for instructions on how to install the driver correctly.

NOTE

If the system software of the H4n is not up to date, the H4n may not be recognized correctly by the computer. You should always upgrade the system software to the latest version. The latest version can also be downloaded from the web site of ZOOM Corporation.

2 Insert the supplied "Cubase LE 4" DVD-ROM into the DVD drive of the computer, and perform the installation steps.

When you insert the DVD-ROM, a screen asking what you want to do appears. Select "Open folder to view files". When the contents of the DVD-ROM are shown, open the "Cubase LE 4 for Windows" folder by double-clicking on it, and then double-click the executable "Setup" ("Setup.exe") file to start the installation process.



HINT

If nothing happens when you insert the DVD-ROM, open the Start menu and select "Computer" ("My Computer" in Windows XP). Then double-click the "Cubase LE 4" DVD-ROM icon to display the contents of the DVD-ROM.

NOTE

When the installation of Cubase LE 4 is complete, a screen asking about installation of activation (software license authentication) management software appears. Install this software, because it is required for registering Cubase LE 4.

3 Connect the H4n to the computer using a USB cable.

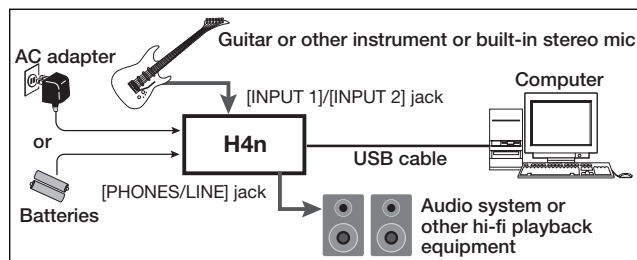

Take the required steps at the H4n to enable USB connection. The H4n will be recognized by the computer. If this is the first time to connect the H4n, wait until the message "Your devices are ready to use" appears.

HINT

For information on steps to take at the H4n, see the section "Setting up: USB connection, H4n used as an Audio Interface" (p.033) of the H4n operation manual.

NOTE

If you monitor the audio signal during recording via the audio output of the computer, there will be an audible delay. Be sure to use the

[PHONES/LINE] jack of the H4n to monitor the signal.
 • Use a high-quality USB cable and keep the connection as short as possible. If USB bus power is supplied to the H4n via a USB cable that is more than 3 meters in length, the low voltage warning indication may appear.

4 Bring up the "Sound" window from the Control Panel and make the input device setting for the computer.

To bring up the "Sound" window, select "Control Panel" from the Start menu and click "Hardware and Sound", then click "Sound".

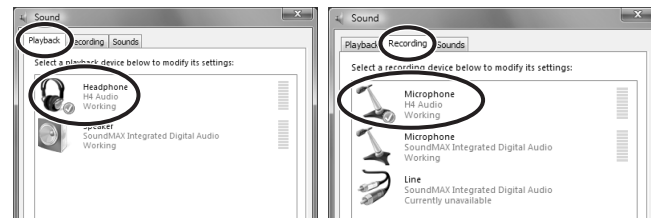

In the "Sound" window, verify that "H4 Audio" is listed under the Play and Record devices and that the device is checked. (To switch between Play and Record, click the tabs at the top of the window.) If the device is not checked, right-click on the icon for the device and click "Set as Default Device" so that a check mark appears.

5 Start Cubase LE 4. Then access the "Devices" menu, select "Device Setup..." and click "VST Audio System".

To start Cubase LE 4, double-click the Cubase LE 4 shortcut icon that was created on the desktop. After startup, select "ZOOM H4 ASIO Driver" as the ASIO driver in the right section of the Device Setup window. When you change the ASIO driver selection, a confirmation message appears. Click the "Switch" button.

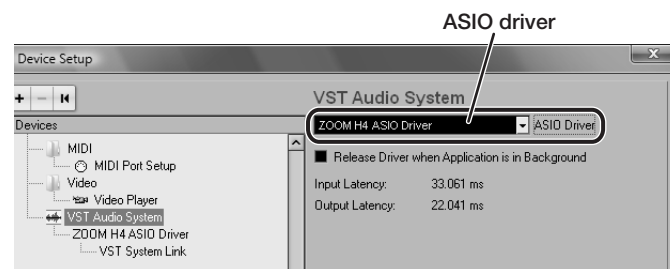

The device indication in the left section of the window now shows "ZOOM H4 ASIO Driver" as the ASIO driver. Click on this indication to select it, and then click the "Control Panel" button in the right section of the Device Setup window.

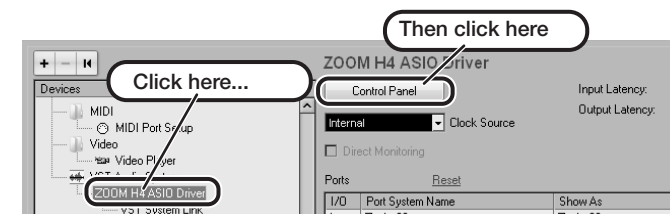

The window that appears lets you set the latency and sampling frequency for the ASIO driver. The latency should be set to a value that is as low as possible without causing sound dropouts during recording and playback. The sampling frequency setting should match the setting of the H4n.

When the setting is complete, click the OK buttons in the respective windows to return to the startup condition of Cubase LE 4.



To connect the H4n to a computer running MacOS X and enable audio input/output, proceed as follows.

1 Insert the supplied "Cubase LE 4" DVD-ROM into the DVD drive of the Macintosh.

The contents of the DVD-ROM appear automatically. If nothing happens when you insert the DVD-ROM, double-click the "Cubase LE 4" icon shown on the desktop.

2 Install Cubase LE 4 on the Macintosh.

When the contents of the DVD-ROM appear, open the "Cubase LE 4 for MacOS X" folder by double-clicking it, and then double-click the "Cubase LE 4.mpkg" file to start the installation process.



Cubase LE 4.mpkg

3 Connect the H4n to the computer using a USB cable.

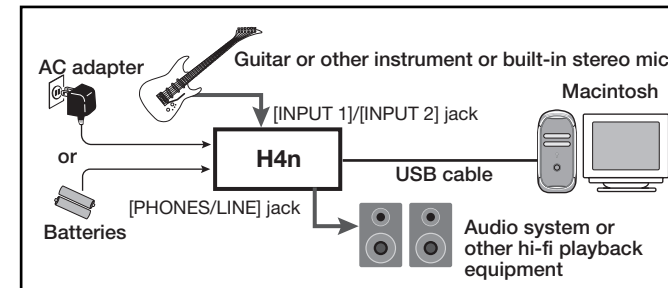

Take the required steps at the H4n to enable USB connection. The H4n will be recognized by the computer.

HINT

For information on steps to take at the H4n, see the section "Setting up: USB connection, H4n used as an Audio Interface" (p.033) of the H4n operation manual.

NOTE

If you monitor the audio signal during recording via the audio output of the computer, there will be an audible delay. Be sure to use the [PHONES/LINE] jack of the H4n to monitor the signal.
 • Use a high-quality USB cable and keep the connection as short as possible. If USB bus power is supplied to the H4n via a USB cable that is more than 3 meters in length, the low voltage warning indication may appear.

4 Open the "Applications" folder and then the "Utilities" folder, and double-click "Audio MIDI Setup".

The Audio MIDI Setup screen appears. Click "Audio Devices" and check whether "H4 Audio" is selected as default input/default output.

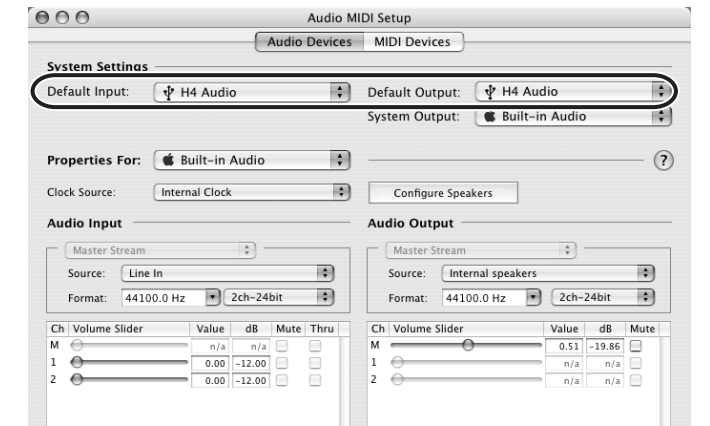

If another device is selected, use the pull-down menu to change the selection to "H4 Audio". When the setting has been made, close Audio MIDI Setup.

5 Start Cubase LE 4. Then access the "Devices" menu, select "Device Setup..." and click "VST Audio System".

To start Cubase LE 4, double-click on the Cubase LE 4 icon that was placed in the "Applications" folder during installation. After startup, be sure to verify that "H4 Audio (2)" is selected as ASIO driver in the right section of the Device Setup window.

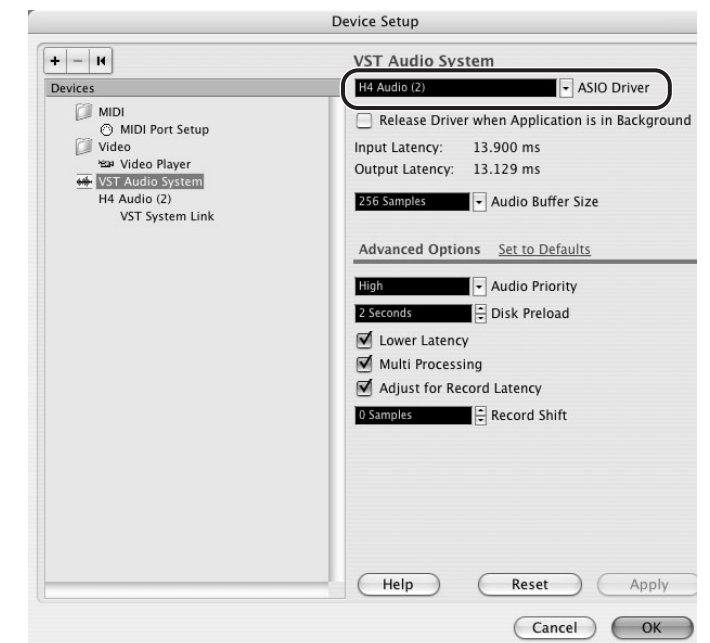

If another item is selected, use the pull-down menu to change the selection to "H4 Audio (2)". When the setting has been made, click the OK button to close the window.



- 6** From the "Devices" menu of Cubase LE 4, select "VST Connections" and select the device containing the string "Zm In (Out)" ("H4 Audio" for MacOS X) as input port and output port.

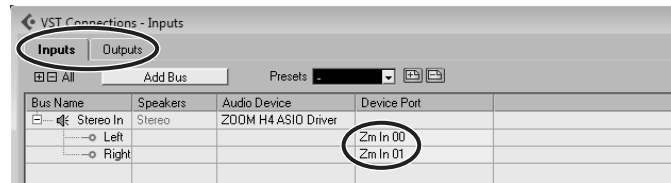

Use the tabs at top (top center for Mac OS X) left to switch between input and output, and verify that "Zm In (Out)" is selected as device port. If another device is selected, click the device port field and change the selection.

- 7** Access the "File" menu and select "New Project".

The new project window appears. Here you can select a project template.

- 8** Make sure that the "Empty" template is selected, and click the OK button.

A window for selecting the project file save location appears.

- 9** After specifying a suitable project file save location (such as the desktop), click the OK button (Choose button in MacOS X).

A new project is created, and the project window for controlling most of the Cubase LE 4 operations appears.

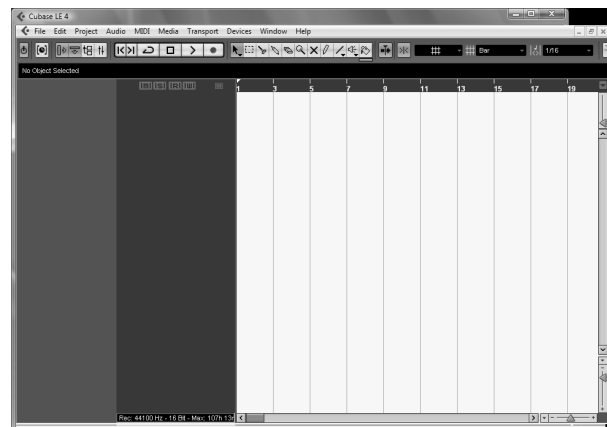

Project window

- 10** To create a new audio track, access the "Project" menu and select "Add track". In the submenu that appears, select "Audio".

The Add Track window for specifying the number of audio tracks and the stereo/mono setting appears.

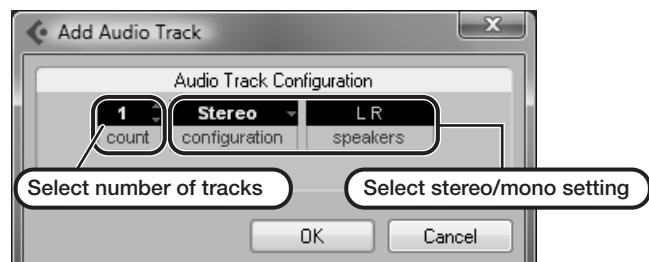

In this example, set the number of tracks to "1" and select stereo, then click the OK button.

A new stereo audio track is added to the project window.



- 11** Make the following settings for the newly created audio track.

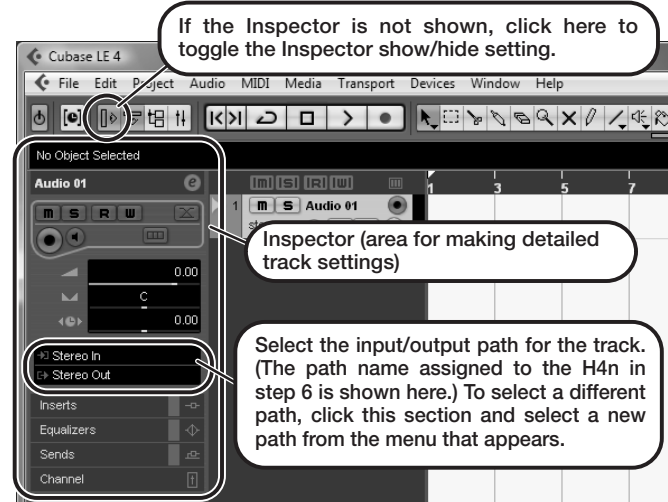

HINT

The Inspector shows information about the currently selected track. If nothing is shown, click on the track to select it.

- 12** Connect the guitar or other instrument to the [INPUT] jack of the H4n and select the desired patch.

The sound selected here will be recorded on the computer via the [USB] port. For information on how to select the input signal and effect patch for the H4n, see page 034 (Selecting the input source) and page 083 (Selecting a patch) of the H4n operation manual.

- 13** Access the "Devices" menu of Cubase LE 4 and select "Mixer".

The mixer window appears. This window shows the channel assigned to the created track, and the master channel.

Perform the following steps here.

Mixer window

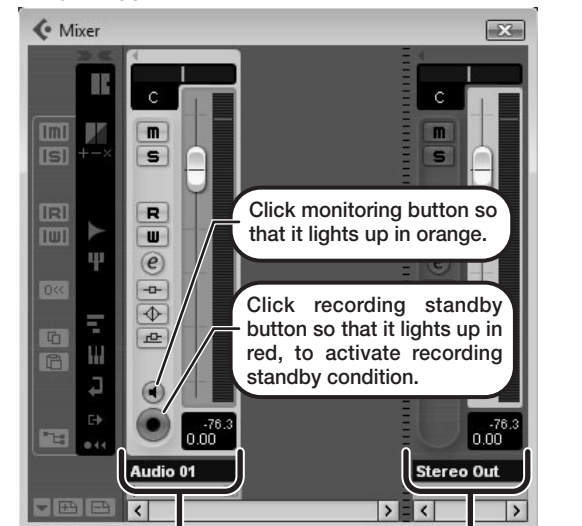

Channel assigned to audio track

Master channel

HINT

When the monitoring button is enabled, the level meter next to the fader shows the input level to the audio track. When the monitoring button is disabled, the meter fader shows the audio track output level.

- 14** While playing your instrument, adjust the output level of the H4n to achieve a suitable recording level for Cubase LE 4.

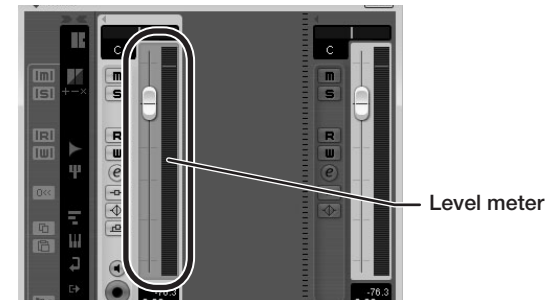

The recording level for Cubase LE 4 can be checked with the level meter for the channel that is assigned to the recording standby track. Set the level as high as possible without causing the meter to reach the end of the scale.

To adjust the level, do not use the fader of Cubase LE 4. Instead change the recording level and gain settings at the H4n.

NOTE

- While the monitoring button is enabled, the direct signal input to the H4n and the signal routed to the computer and then returned to the H4n will be output simultaneously from the H4n, causing a flanger-like effect in the sound. To accurately monitor the sound also while adjusting the recording level, temporarily set the output device port for the VST connection (step 6) to "Not Connected".
- The level meter as in the above illustration shows the signal level after processing in the H4n. When you pluck a guitar string the meter may register with a slight delay, but this is not a defect.

- 15** When the recording level has been adjusted, click the monitoring button to disable it.

The input level is no longer shown on the meter, and the signal returned to the H4n via the computer is muted. In this condition, only the signal before sending to the computer can be monitored via the [PHONES/LINE] jack of the H4n.

- 16** Verify that the transport panel is being shown.



If the transport panel is not shown, access the "Transport" menu and select "Transport Panel".

- 17** To start recording, click the Record button in the transport panel.



Stop button Record button

Recording starts. As you play your instrument, the waveform appears in real time in the project window. To stop recording, click the Stop button in the transport panel.

- 18** Check the recorded content.

To play the recording, perform the following steps.

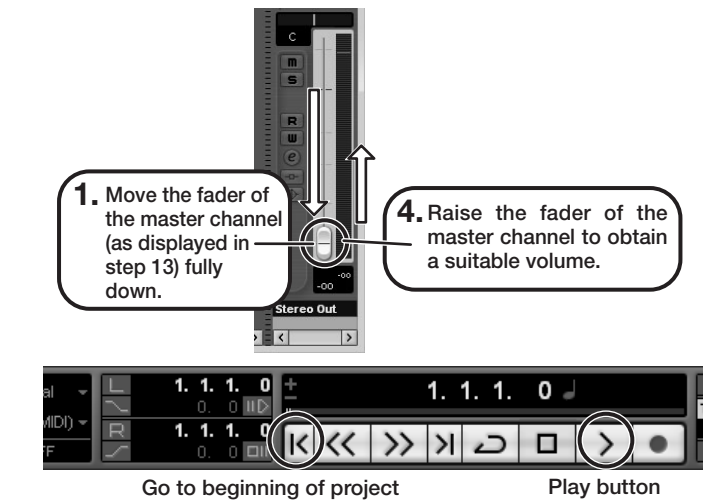

- 2.** Use the button in the transport panel to move to the beginning of the project.

- 3.** Click the Play button in the transport panel to start playback.

HINT

If no sound is heard when you click the Play button after recording, check the VST connection settings (step 6) once more.

NOTE

To continue using Cubase LE 4, a process called activation (license authentication and product registration) is necessary. When you start Cubase LE 4, a screen offering to register the product will appear. Select "Register Now". A web site for registration will open in your Internet browser. Follow the instructions on that page to register and activate the product.

For optimum enjoyment

While using Cubase LE 4, other applications may slow down drastically or a message such as "Cannot synchronize with USB audio interface" may appear. If this happens frequently, consider taking the following steps to optimize the operation conditions for Cubase LE 4.

- Shut down other applications besides Cubase LE 4.**
In particular, check for resident software and other utilities.
- Reduce plug-ins (effects, instruments) used by Cubase LE 4.**
When there is a high number of plug-ins, the computer's processing power may not be able to keep up. Reducing the number of tracks for simultaneous playback can also be helpful.
- Power the unit from an AC adapter.**
When a device designed to use USB power is powered via the USB port, the current supply may sometimes fluctuate, leading to problems. See if using an AC adapter improves operation.

If applications still run very slowly or the computer itself does not function properly, disconnect the H4n from the computer and shut down Cubase LE 4. Then reconnect the USB cable and start Cubase LE 4 again.